

Flooring Accessories

STIKATAK *Gripperods*

The one stop shop for flooring accessories

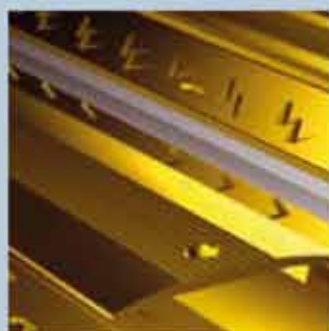

Carpet Gripper

*Carpet & Vinyl
Floor Edgings*

*Wood / Laminate
Floor Edgings*

*Stair Nosings &
Finishing Products*

Flooring Adhesives



Heat Seaming Tapes

*Single & Double
Sided Tapes*

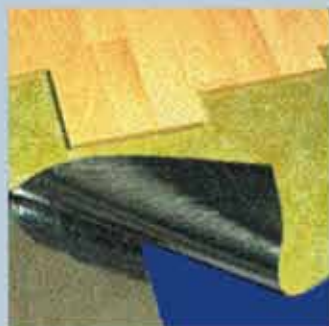

Tools, Blades & Fixings

*Wood / Laminate
Underlays*

Retail Packaged Products

Welcome to the one stop shop for flooring accessories

Our new, and improved, 2009/2010 Flooring Accessories catalogue offers the widest choice of products in the market. By combining the very best of the Stikatak and Gripperods ranges we now offer over 800 quality products which makes Interfloor the one stop shop for flooring accessories.

We've chosen the products which offer the best quality and value from each range. This has enabled us to construct

the most comprehensive flooring accessory portfolio in the industry, offering everything from floor edgings to adhesives, and from stair nosings to carpet gripper.

This means, for the first time, we can offer a complete range of product options and price points in key areas. For example we now offer a "Good, Better, Best" range of carpet gripper with Stikatak Regular, Gripperods Tackfast and Gripperods Golden Gripper. We're also able to offer both the Gripperods and Stikatak ranges of double sided tapes, maximising your choice in terms of both performance and price.

The new catalogue has been designed for ease of use and includes:

- Detailed contents and indexing
- Adhesives and screed product selector
- Unique product coding for every product
- Cross sectional & dimensional images for all metal profiles

We are constantly striving to improve our range and if you have any suggestions or comments that you would like to make please contact us via productideas@interfloor.com.

What's new

Flooring Adhesive Range

NEW



Introducing our new range of Stikatak flooring adhesives manufactured in the U.K. We produce a range of high quality, environmentally friendly, low VOC adhesives and our R&D and Technical teams ensure that our products are suitable for use with the latest trends in floorcoverings and health and safety requirements.

(See Page 21)

Floor Edge Trim

NEW



The new Floor Edge Trim is a patented product which has been designed to bridge the expansion gap between wood/laminate flooring and the skirting. It is self adhesive, easy to fit and sits flat to the floor giving a clean, smart finish.

Available in 6 colours.

(See Page 13)

Flooring Screeds

NEW



The new Stikatak range of flooring screeds now includes STK 1200 which is a water-based cementitious smoothing compound containing specially graded fillers, fine cements and polymers for smoothing and levelling internal floors prior to the application of floor coverings.

STK 1300/1350, is a two-part latex based smoothing compound used for preparing and levelling of most interior floors prior to the floor covering installation.

(See Page 26)

Contents *(see page 53 for full product index)*

Carpet Gripper



Gripperrods

2

The range now consists of Gripperrods Golden, Tackfast and Contract gripper and Stikatak's Regular gripper in specifications suitable for every carpet and sub-floor. In addition Floorworks gripper and tapes are for the tension fitting of felt backs and Blind gripper is designed to give a neat edge to single and double stick installations.

Carpet & Vinyl Floor Edgings



5

An edging for every textile and smooth floor covering. Available in a variety of finishes for that perfect finish - Polished Aluminium, Anodised Gold, Matt Gold, Matt Silver and Solid Brass.

Wood / Laminate Floor Edgings



10

An edging to suit all wood and laminate floors including our clip system that is suitable for floor thicknesses up to 21mm. Available in a variety of metal and wood effect finishes to complement floor covering décors. Self adhesive Floor Edge Trims are now an important part of our range, offering greater flexibility for the flooring installer.

Stair Nosings & Finishing Products



15

Stikatak's extensive range of stair nosings and finishing products consist of both slimline and heavy duty aluminium profiles. Available with PVC inserts in a choice of 11 colours and a comprehensive range of PVC nosings, skirtings and cove formers.

Flooring Adhesives



21

The range includes multipurpose adhesives and tackifiers for direct stick-down, single and double stick installations for carpet and carpet tiles. Acrylic adhesives are available for the installation of vinyl flooring. We also offer a wide range of spray and cartridge adhesives for fixing gripper and edgings.

Heat Seaming Tapes

Gripperrods

30

Quality specifications for every type of carpet and traffic conditions. Economy versions for lower traffic conditions. Silvaseam ironless seaming system.

Single & Double Sided Tapes



Gripperrods

32

Double sided contact tape for upstands including flexible vinyls. Underlay joining tapes for stretch and single/double stick applications. Double sided tapes for all carpets and vinyls. Vapour barrier tape and strip for joining underlays beneath wood and laminate floors.

Tools, Blades & Fixings



Gripperrods

34

A broad selection of tools for floor preparation, adhesive and screed application, measuring and marking, cutting and trimming, fixing, seaming, stretching and vinyl installation. Blades and fixings for all applications. Tool kits, knee pads and carpet carriers.

Wood/Laminate Underlays



42

A range of light polyethylene and high density rubber underlay for use under laminate, solid timber and engineered wooden floors.

Retail Packaged Products



43

A range of retail packaged flooring accessories, designed to help the retailer when presenting in store.

A comprehensive range of carpet grippers for any type of installation



We are the only company manufacturing gripper in the UK and now offer the most complete choice of carpet gripper available, giving a range of products to suit any nail down installation.

Our range consists of Golden, Tackfast and Regular Gripper which are used in both contract and domestic installations. We also offer a Contract specification which is a specialist product used for particularly heavy stretch installations.

In addition to products for traditional stretch carpet fitting we also offer specialist items for the tension fitting of felt backed carpets.

Golden Gripper	Gripperods	BEST
<p>Golden Gripper is manufactured in the UK from 5 ply Russian Birch plywood, a hardwood plywood of consistent density, and has a wider 25mm (1") strip than both Tackfast and Regular gripper. This gives greater stability on the floor in nail down applications.</p> <p>It also has 10% more precision made floorholding nails and a greater number of precision pins than Tackfast and Regular, which gives better holding in all types and qualities of sub floor and higher strength in heavy stretch installations.</p>		
Tackfast Gripper	Gripperods	BETTER
<p>Tackfast gripper is also produced in the UK from 5 ply Russian Birch plywood and has a 20.3mm strip with a pronounced bevel edge for an easy and consistent roll edge finish.</p> <p>The precision made nails are made to exacting hardness standards to penetrate and hold in any sub floor and the precision pins are designed for the carpet holding strength required.</p> <p>It is available in all three pin heights and floor nail specifications.</p>		
Regular Gripper	STIKATAK	GOOD
<p>Regular carpet gripper is made of 5 ply Poplar plywood, which gives a good quality alternative to Russian Birch plywood.</p> <p>The zinc plated nails and galvanised pins are precision made to hold in any sub floor and give the carpet holding strength required.</p> <p>Available with wood, concrete and dual purpose nails and medium pin.</p>		

Gripperods Golden Gripper®









Available in all three pin heights with wood or concrete floor nails or with no nails for stickdown application.
See page 29 for adhesives
100 x 1.52m (5') Lengths
152.3m (500') Per Carton

	Long Pin 6.4mm (1/4") For heavy reinforced backed carpets used in commercial situations.	Medium Pin 4.8mm (3/16") The more usual pin length, suitable for most types of carpets.	Short Pin 3.2mm (1/8") For cord carpeting and some low tuft carpets.
		Stick Down Medium Pin 2110	
Wood Long Pin 2220		Wood Medium Pin 2120	Wood Short Pin 2020
Grippercrete Long Pin 2240		Grippercrete Medium Pin 2140	

For stretch installations

Gripperods TACKFAST range of gripper is manufactured using high quality Russian Birch plywood with a pronounced bevel edge for an easy and consistent roll edge finish. It is available in pin heights suitable for any carpet and nail specifications suitable for any sub-floor.

Gripperods Tackfast™

	Long Pin 6.4mm (1/4") For heavy reinforced backed carpets used in commercial situations.	Medium Pin 4.8mm (3/16") The more usual pin length, suitable for most types of carpets.	Short Pin 3.2mm (1/8") For cord carpeting and some low tuft carpets.
Stick Down Standard TACKFAST is ideal for use on modern wooden staircases where fixing by nails is unsuitable. It is ideal for applications where special fixing methods are required e.g. adhesive (pg 29) or specialist nails (pg 37) 100 x 1.52m (5') Lengths 152.3m (500') Per Carton	 3110 Medium Pin		
Pre-Nailed for wood floors Pre-nailed for ease and speed of installation when fitted to boarded or suspended timber floors, with specially tempered nails (threaded for holding power), pre-driven into the gripper. 100 x 1.52m (5') Lengths 152.3m (500') Per Carton	 3220 Long Pin	 3120 Medium Pin	 3020 Short Pin
Grippercrete Designed for ease of installation on concrete floors. Pre-nailed with high quality masonry nails for a firm fixing. 100 x 1.52m (5') Lengths 152.3m (500') Per Carton	 3240 Long Pin	 3140 Medium Pin	Custom Printed Gripper We can supply gripper printed to your own personal requirements. Available in Golden and Tackfast specifications in medium pin only. Please contact your Sales Representative or our Sales Office for details of how to order gripper printed to your requirements.
Dual Purpose Pre-nailed with dual purpose nails. Suitable for most wood and concrete based floors. 100 x 1.52m (5') Lengths 152.3m (500') Cartons	 3270 Long Pin	 3170 Medium Pin	

Gripperods Contract Gripper

Gripperods CONTRACT gripper is a specialist product for particularly heavy stretch installations. It is 42mm wide and has 3 rows of carpet holding pins compared to the two rows in other gripper specifications. It is available in medium pin height only and without floor nails. This allows the fitter to install by nailing or adhering the gripper to the floor, depending on the installation. See Page 29 for adhesives. See Page 37 for nails. 50 x 1.52m (5') Lengths 76m (250') Per Carton	Medium Pin 4.8mm (3/16") The more usual pin length, suitable for most types of carpets.	 6942 Medium Pin
--	---	---

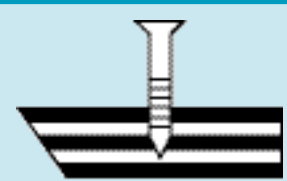
Wood Neat Edge (Blind Gripper)		This gripper enables the installer to create the perfect finished appearance around the wall for single and double stick installations. Based on Tackfast gripper with dual purpose pre-nails, but no pins. 3370 100 x 1.52m (5') Lengths 152.3m (500') Per Carton
---------------------------------------	---	---

For stretch installations



Regular

Regular for wood floors

Pre-nailed for ease and speed of installation when fitted to boarded or suspended timber floors, with specially tempered nails (threaded for holding power), pre-driven into the gripper.

100 x 1.52m (5') Lengths
152.3m (500') Per Carton

Regular for Concrete

Designed for ease of installation to concrete floors. Pre-nailed with masonry nails for a firm fixing into concrete floors.

100 x 1.52m (5') Lengths
152.3m (500') Per Carton

Regular Dual Purpose

Pre-nailed with dual purpose nails. Suitable for most wood and concrete based floors.

100 x 1.52m (5') Lengths
152.3m (500') Cartons

Medium Pin
4.8mm (3/16")
The more usual pin length, suitable for most types of carpets.

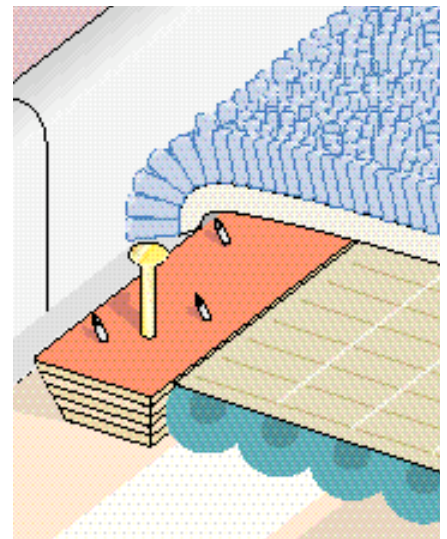
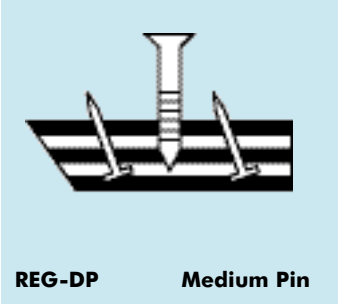
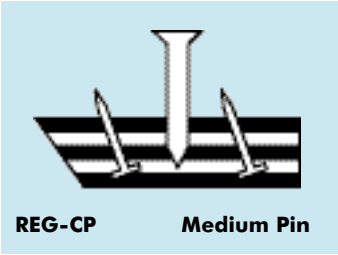
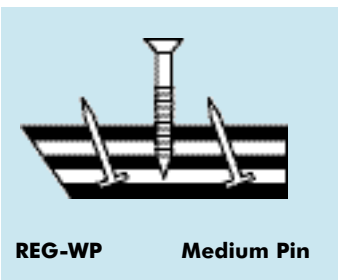

For felt backed carpet installation

Gripperods

With the growth in felt backed carpets, retailers should still aim to benefit from the additional profit margin of an underlay sale. Felt backed carpet installations benefit from the use of underlay in the same way that traditional carpets do. The Floorworks System allows the installer to achieve a tension fit resulting in better appearance retention and wear characteristics.

Consumers also benefit from distinctly improved carpet appearance, retention and walking comfort when a rubber underlay is used beneath a felt backed carpet. Floorworks Easy Gripper is designed for the installation of felt backs with underlay in all areas. Mushroom tape is available for fitting felt backs without underlay (see page 33).

For suitable underlays please contact your Sales Representative or our Sales Office.

Floorworks Microplast™ Easy Gripper For Flat Areas

Designed for use with underlay to give the best finished appearance to the installation and the best wear characteristics. Microplast™ tape top surface and dual purpose floor pre-nails for fast, good finish, tension fit installations on underlay.

FW007 100 x 1.52m (5'),
152m (500') Cartons

Floorworks Microplast™ Easy Gripper For Stairs

Specially designed for use on stairs. A combination of Microplast™ tape and standard profile gripper pins. The pins prevent the aggressive Microplast™ tape from gripping the felt back prematurely prior to the carpet being tucked into the stair gully.

Once tucked in, the pins combine with the Microplast™ tape to give the high holding strength required on stairs.

FW008 100 x 1.52m (5'),
152m (500') Cartons

A comprehensive range of high quality edgings with a choice of finishes

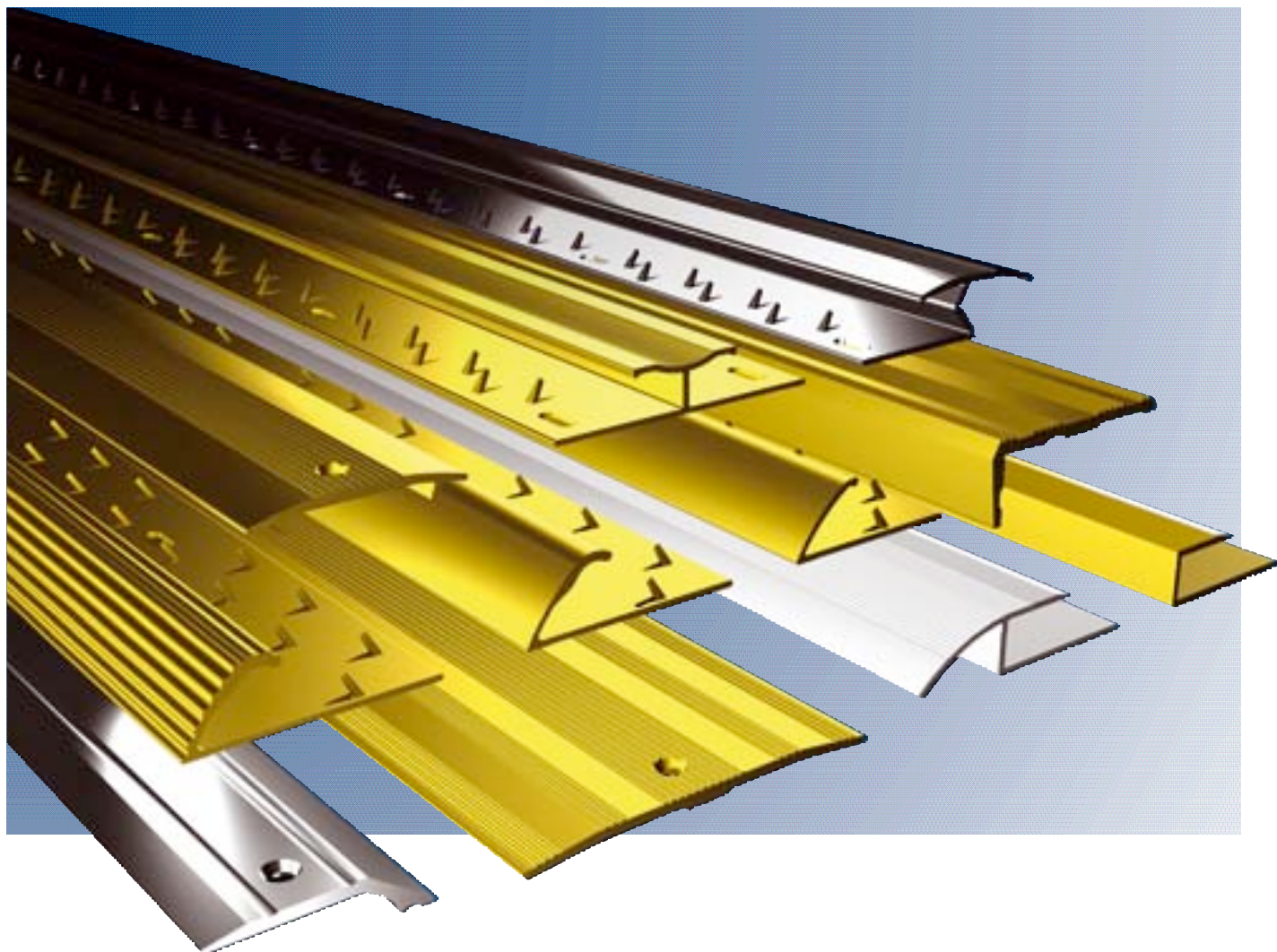

We have rationalised the Stikatak and Gripperods range of metal edgings and chosen the products which offer the best quality and value from each range, enabling us to offer the most complete portfolio of edgings available.

To simplify the identification of the metals product range we have chosen the Stikatak code numbers and each product in the section has the full code number shown.

Where necessary each product has fixings provided and a protective film for the showface.



Finishes available are:

- Polished Aluminium.
- Gold Anodised gives a hard wearing anodised finish, simulating a brass effect.
- Matt Silver and Matt Gold gives a hard wearing anodised finish.
- Polished Solid Brass for top quality domestic and contract use.
- Wood effect finish is available in various colours on most wood / laminate profiles.







Metal Edgings



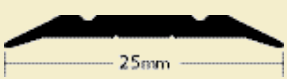
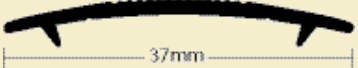

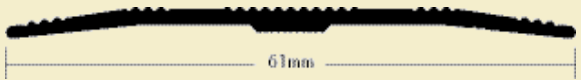

Vinyl Edges

	Finish	0.90m x 45 Per Carton	2.70m x 15 Per Tube	2.70m x 10 Per Tube
Vinyl Edge - Small For resilient floor coverings up to 4mm thick. Has a high lustre finish in both gold anodised and polished aluminium. Includes fixings.				
	Aluminium	M02.3A	M02.9A	-
	Gold	M02.3G	M02.9G	-
Vinyl Edge - Medium For resilient floor coverings up to 5mm thick. Has a high lustre finish in both gold anodised & polished aluminium. Includes fixings.				
	Aluminium	M03.3A	M03.9A	-
	Gold	M03.3G	M03.9G	-

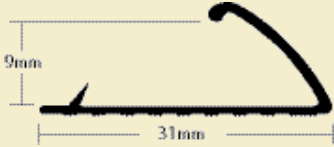
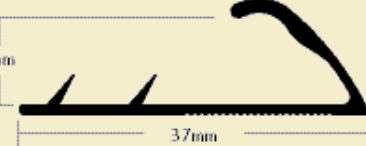
Coverstrips

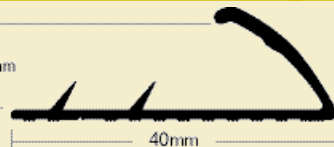
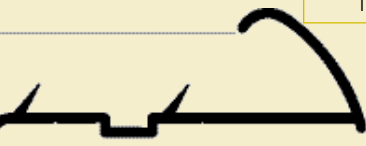
	Finish	0.90m x 45 Per Carton	2.70m x 15 Per Tube	2.70m x 10 Per Tube
Vinyl Coverstrip Conceals and protects joins between all grades and thicknesses of resilient floor coverings. High lustre finish in both gold anodised and polished aluminium. Includes fixings.				
	Aluminium	M01.3A	M01.9A	-
	Gold	M01.3G	M01.9G	-
Carpet Coverstrip The angled ribs extruded on the underside lock into the carpet pile and draw the two edges together when the strip is screwed to the floor. Suitable for use with all types of carpet. High lustre finish in both gold anodised and polished aluminium. Includes fixings.				
	Aluminium	M10.3A	M10.9A	-
	Gold	M10.3G	M10.9G	-
Contract Coverstrip Designed for use with low pile carpets, carpet tiles or resilient floor coverings. High lustre finish in both gold anodised and polished aluminium. Includes fixings.				
	Aluminium	M11.3A	M11.9A	-
	Gold	M11.3G	M11.9G	-
Coverstrip Extra Wide The widest Coverstrip in the range to cover difficult joins between any floor coverings. Includes fixings.				
	Aluminium	M12.3A	M12.9A	-
	Gold	M12.3G	M12.9G	-
Euro Coverstrip High quality coverstrip for use with most flooring types of equal levels. Also available in self adhesive (pg 10). Includes fixings.				
	Gold	-	M13.9G	-
	Matt Gold	-	M13.9GM	-
Coverstrip Solid Brass High quality, solid brass profile suitable for heavy traffic areas on carpet or resilient floors. Includes fixings.				
	Solid Brass	-	-	1759

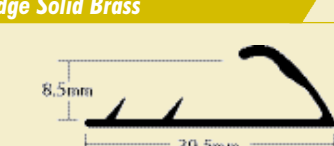
Single Edges

	Finish	0.90m x 45 Per Carton	2.70m x 15 Per Tube	2.70m x 10 Per Tube
Carpet Edge - Narrow High lustre finishes in both gold anodised and polished aluminium. The lighter version of Carpet Edge - Standard.				
	Aluminium Gold	M29.3A M29.3G	M29.9A M29.9G	- -
Carpet Edge - Standard High lustre finishes in both gold anodised and polished aluminium.				
	Aluminium Gold	M20.3A M20.3G	M20.9A M20.9G	- -
Carpet Edge - Without Teeth Carpet Edge Standard without teeth. Suitable for double stick installations, foam backed carpets and carpet tiles.				
	Aluminium	-	M20.9A-UNP	-
Carpet Edge - Heavy Duty Heavy duty version of the carpet edge with wider base for use with thicker carpets.				
	Aluminium Gold	- -	M28.9A M28.9G	- -
Carpet Edge - Heavy Duty Raised Base This heavy duty version of the Carpet Edge is designed to secure the heavier grade of contract carpet. The wider base & the high lustre gold anodised finish gives a 'quality' look to the flooring installation.				
	Aluminium Gold	M21.3A M21.3G	M21.9A M21.9G	- -
Carpet Edge - Fluted As Carpet Edge Standard, but with fluting to give a rich tone against the carpet.				
	Aluminium Gold	- -	M22.9A M22.9G	- -
Carpet Edge Solid Brass For the highest class finish, polished natural brass.				
	Solid Brass	-	-	1259
Foam Edge For use with felt and foam backed carpets.				
	Aluminium Gold	- -	M24.9A M24.9G	- -

Single Edges continued

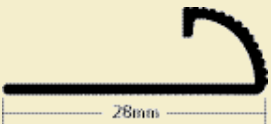
	Finish	1.21m x 10 Per Carton	0.90m x 45 Per Carton	2.70m x 15 Per Tube	2.70m x 10 Per Tube
Carpet Tile Edging					
Specifically designed to protect the exposed edges of loose laid carpet tiles where no wall line exists.					
	Aluminium	-	-	M25.9A	-
	Gold	-	-	M25.9G	-

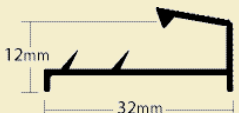
Square Edge					
Can be used for a variety of installations, as a carpet capping or finishing to open plan areas, easily mitred to form an access panel. Finished with a fine ribbed design which will keep its appearance even when subjected to heavy traffic.					
	Aluminium	-	M72.3A	M72.9A	-
	Gold	-	M72.3G	M72.9G	-

Gripperrods Karpetedge™

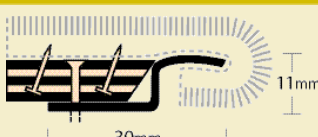
Karpetedge™					
Used in conjunction with carpet gripper, Karpetedge™ provides a perfect, rolled edge finish to the carpet on flush surfaces in low traffic areas. It is ideal for providing a finish to open landings or coved skirtings.					
	Aluminium	7011	-	-	-

STIKATAK Zig Zag™

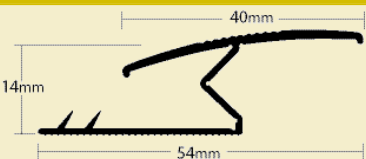
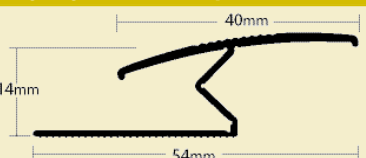
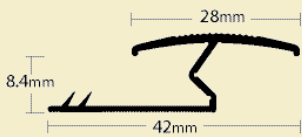
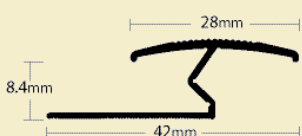
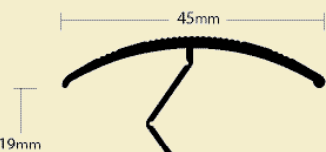
	Finish	0.90m x 27 Per Carton	0.90m x 45 Per Carton	2.70m x 15 Per Tube	2.70m x 10 Per Tube
Zig Zag™ - 14mm					
Zig Zag 14mm with teeth. Gives a neat transition between laminate/smooth flooring and adjacent stretch carpet installation. Top of section should be lightly dressed down using a rubber mallet after fitting, to ensure a snug fit to edges of both floor coverings.					
	Aluminium	-	-	-	M33.9A
	Gold	-	-	-	M33.9G
	Matt Gold	-	-	-	M33.9GM
Zig Zag™ - 14mm - Unpunched					
As Zig Zag 14mm but without teeth. Can be used in conjunction with wooden and ceramic floorings where different height levels are required.					
	Aluminium	-	-	-	M33.9A-UNP
	Gold	-	-	-	M33.9G-UNP
	Matt Gold	-	-	-	M33.9GM-UNP
Zig Zag™ - 9mm					
Zig Zag 9mm with teeth. Gives a neat transition between laminate/smooth flooring and adjacent stretch carpet installation. Top of section should be lightly dressed down using a rubber mallet after fitting, to ensure a snug fit to edges of both floor coverings.					
	Aluminium	-	M34.3A	M34.9A	-
	Gold	-	M34.3G	M34.9G	-
	Matt Silver	-	M34.3AM	M34.9AM	-
	Matt Gold	-	M34.3GM	M34.9GM	-
Zig Zag™ - 9mm - Unpunched					
As Zig Zag 9mm but without teeth. Can be used in conjunction with wooden gripper for laminate/smooth flooring to carpet installations.					
	Aluminium	-	-	M34.9A-UNP	-
	Gold	-	-	M34.9G-UNP	-
	Matt Silver	-	-	M34.9AM-UNP	-
	Matt Gold	-	-	M34.9GM-UNP	-
Zig Zag™ - 19mm					
Zig Zag 19mm without teeth. Gives a neat transition between laminate/smooth flooring and adjacent stretch carpet installation. Top of section should be lightly dressed down using a rubber mallet after fitting, to ensure a snug fit to edges of both floor coverings.					
	Aluminium	-	-	-	M35.9A
	Gold	-	-	-	M35.9G
	Matt Gold	-	-	-	M35.9GM

The one stop shop for flooring accessories

STIKATAK Gripperrods

Dualgrip™

	Finish	0.90m x 27 Per Carton	0.90m x 45 Per Carton	2.70m x 15 Per Tube	2.70m x 9 Per Tube
Dualgrip™ - Standard					
The industry standard with a full 20mm top and 50mm base, available in high lustre finishes in both gold anodised and polished aluminium.					
	Aluminium	-	M30.3A	M30.9A	-
	Gold	-	M30.3G	M30.9G	-
Dualgrip™ - Heavy Duty					
Heavy duty version with 28mm top and 62mm base.					
	Aluminium	M31.3A	-	-	M31.9A
	Gold	M31.3G	-	-	M31.9G
Dualgrip™ - Heavy Duty Raised Base					
This heavy duty version of the raised base Dualgrip is designed to secure the heavier grade of contract carpet. Recommended for the best installations. The wider top and the high lustre gold anodised finish gives that 'quality' look that can't be achieved using the standard product.					
	Aluminium	M32.3AL	-	-	M32.9A
	Gold	M32.3G	-	-	M32.9G
Dualgrip™ - Raised Base					
Raised base the best type of double edge for carpets fitted with underlay, which is cut to butt up to the lips of the profile giving the smoothest transition to the finished installation.					
	Aluminium	-	-	M37.9A	-
	Gold	-	-	M37.9G	-
Dualgrip™ - Raised Base Solid Brass					
A high quality solid brass profile for the highest class finish.					2.70m x 6 Per Tube
	Solid Brass	-	-	-	4469

Angle edges / Stair nosings

	Finish	0.90m x 27 Per Carton	0.90m x 45 Per Carton	2.70m x 15 Per Tube	2.70m x 10 Per Tube
Small Angle Section					
For applications requiring a right angled finish. Plain one edge, ribbed on the other. Undrilled.					
	Aluminium	-	-	M70.9A	-
	Gold	-	-	M70.9G	-
Matwell Edging					
For any application where a right angled edging is required and offering a higher quality finish than the small angle section. Particularly suitable for mat wells, where the ridged surface provides a non-slip finish to the installation. Undrilled.					
	Aluminium	-	-	M71.9A	-
	Gold	-	-	M71.9G	-
Stair Nosing (with separate insert)					
Stair nosings with anti slip black ribbed vinyl insert; ideal for light commercial or domestic use. Inserts included separately in the tube, to be fitted after the metal nosing has been fixed to the stair.					
	Aluminium	-	-	-	19419
	Gold	-	-	-	19439

Edgings & Trims for wood/laminate floors



Angle edges

	Finish	0.90m x 40 Per Carton	0.90m x 45 Per Carton	2.70m x 15 Per Tube	2.70m x 10 Per Tube
Angle Edge - 8mm					
Gives a smooth transition down to resilient floorings. Drilled, and supplied with screws.					
	Aluminium	-	-	M04.9A	-
	Gold	-	-	M04.9G	-
Angle Edge - 8mm - Self Adhesive					
Self adhesive version of the 8mm Angle Edge.					
	Matt Silver	-	-	-	M04.9AMA
	Matt Gold	-	-	-	M04.9GMA
	Beech	-	-	-	M04.9WBA
	Oak	-	-	-	M04.9WOA
Angle Edge - 14mm					
14mm version of the 8mm Angle Edge. Drilled and supplied with screws.					
	Gold	-	-	M05.9G	-
	Matt Gold	-	-	M05.9GM	-
Angle Edge - 14mm - Self Adhesive					
Self adhesive version of the 14mm Angle Edge.					
	Matt Silver	-	-	-	M05.9AMA
	Matt Gold	-	-	-	M05.9GMA
	Beech	-	-	-	M05.9WBA
	Oak	-	-	-	M05.9WOA
Angle Edge - 20mm - Self Adhesive					
Self adhesive 20mm version of the above Angle Edge.					
	Matt Silver	-	-	-	M06.9AMA
	Matt Gold	-	-	-	M06.9GMA

Euro Coverstrips

	Finish	0.90m x 40 Per Carton	0.90m x 45 Per Carton	2.70m x 15 Per Tube	2.70m x 10 Per Tube
Euro Coverstrips - 38.5mm					
High quality coverstrip for use with most flooring types of equal levels. Drilled and supplied with screws.					
	Gold	-	-	M13.9G	-
	Matt Gold	-	-	M13.9GM	-
Euro Coverstrips - 38.5mm - Self Adhesive					
Self adhesive version of above coverstrip.					
	Matt Silver	-	-	-	M13.9AMA
	Matt Gold	-	-	-	M13.9GMA
	Maple/Ash	-	-	-	M13.9WASA
	Beech	-	-	-	M13.9WBA
	Oak	-	-	-	M13.9WOA

Zig Zag™ - 9mm

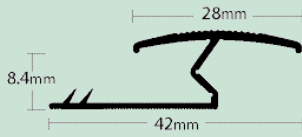

Zig Zag Section 9mm but without teeth. Gives a smooth transition between laminate and an adjacent stretch carpet installation. Top of section should be lightly dressed down using a rubber mallet after fitting, to ensure a snug fit to edges of both floor coverings.

Finish	0.90m x 40 Per Carton	0.90m x 45 Per Carton	2.70m x 15 Per Tube	2.70m x 10 Per Tube
Aluminium	-	M34.3A	M34.9A	-
Gold	-	M34.3G	M34.9G	-
Matt Silver	-	M34.3AM	M34.9AM	-
Matt Gold	-	M34.3GM	M34.9GM	-
Beech	M34.3WB	-	M34.9WB	-
Oak	M34.3WO	-	M34.9WO	-

Zig Zag™ - 9mm - Unpunched

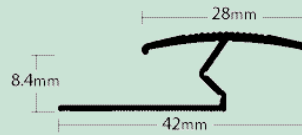

As Zig Zag Section 9mm but without teeth.

Aluminium	-	-	M34.9A-UNP	-
Gold	-	-	M34.9G-UNP	-
Matt Silver	-	-	M34.9AM-UNP	-
Matt Gold	-	-	M34.9GM-UNP	-

Zig Zag™ - 14mm

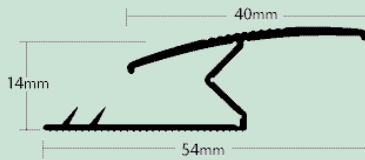

14mm version of 9mm Zig Zag Section. Gives a smooth transition between laminate and an adjacent stretch carpet installation. Top of section should be lightly dressed down using a rubber mallet after fitting, to ensure a snug fit to edges of both floor coverings.

Aluminium	-	-	-	M33.9A
Gold	-	-	-	M33.9G
Matt Gold	-	-	-	M33.9GM

Zig Zag™ - 14mm - Unpunched

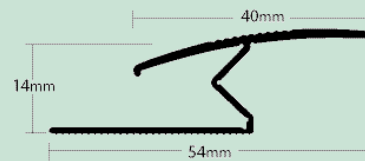

14mm version of 9mm Zig Zag Section but without teeth.

Aluminium	-	-	-	M33.9A-UNP
Gold	-	-	-	M33.9G-UNP
Matt Gold	-	-	-	M33.9GM-UNP

Zig Zag™ - 19mm

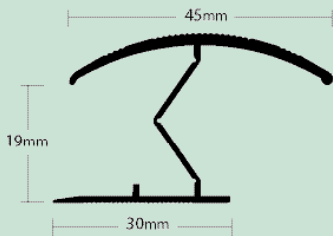

Zig Zag 19mm without teeth. Gives a smooth transition between laminate and an adjacent stretch carpet installation. Top of section should be lightly dressed down using a rubber mallet after fitting, to ensure a snug fit to edges of both floor coverings.

Aluminium	-	-	-	M35.9A
Gold	-	-	-	M35.9G
Matt Gold	-	-	-	M35.9GM

Roundedge™

Roundedge™ - 8.5mm

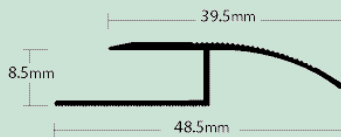

Gives a smooth transition down to adjacent resilient flooring. Fits over edge of laminate. Allows for expansion. No screws or fixings required.

Finish	0.90m x 30 Per Carton	2.70m x 10 Per Tube
--------	--------------------------	------------------------

Gold	-	M83.9G
Matt Silver	-	M83.9AM
Matt Gold	M83.3GM	M83.9GM
Oak	-	M83.9WO

Roundedge™ - 14.5mm

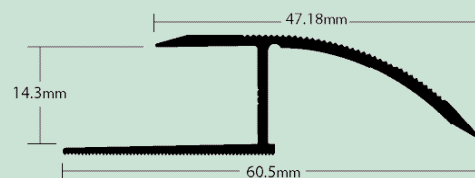

14.5mm version of the round edge 8.5mm.

Gold	-	M80.9G
Matt Silver	-	M80.9AM
Matt Gold	-	M80.9GM

Nosings

	Finish	0.90m x 40 Per Carton	0.90m x 45 Per Carton	2.70m x 15 Per Tube	2.70m x 10 Per Tube
Nosings - 9mm					
	Ideal for use on wood / laminate flooring where a neat finish is required.				
	Gold	-	-	-	M74.9G

Nosings - 9mm - Self adhesive					
	Ideal for use on wood / laminate flooring where a self adhesive fixing is required.				
	Matt Silver	-	-	-	M74.9AMA
	Matt Gold	-	-	-	M74.9GMA
	Maple/Ash	-	-	-	M74.9WASA
	Beech	-	-	-	M74.9WBA
	Oak	-	-	-	M74.9WOA

Nosings - 15mm					
	15mm version of the 9mm nosing. Ideal for use on wood / laminate flooring where a neat finish is required.				
	Gold	-	-	-	M75.9G

Nosings - 15mm - Self adhesive					
	15mm version of the 9mm nosing Ideal for use on wood / laminate flooring where a self adhesive fixing is required.				
	Matt Silver	-	-	-	M75.9AMA
	Matt Gold	-	-	-	M75.9GMA
	Beech	-	-	-	M75.9WBA
	Oak	-	-	-	M75.9WOA

Nosings - 20mm - Self adhesive					
	20mm version of the 9mm nosing Ideal for use on wood / laminate flooring where a self adhesive fixing is required.				
	Matt Silver	-	-	-	M76.9AMA
	Matt Gold	-	-	-	M76.9GMA
	Beech	-	-	-	M76.9WBA
	Oak	-	-	-	M76.9WOA

Nosings - 23mm - Self adhesive					
	Heavy duty version of the 20mm nosing. With slight bull nose.				
	Matt Silver	-	-	-	M78.9AMA
	Matt Gold	-	-	-	M78.9GMA

Doubledge™

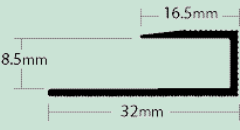

	Finish	0.90m x 30 Per Carton	0.90m x 45 Per Carton	2.70m x 15 Per Tube	2.70m x 10 Per Tube
Doubledge™ - 8.5mm					
	Gives a pleasing finish covering the joint between two areas of laminate. Fits over two adjacent laminate edges allowing for expansion. No screws or fixings required.				
	Gold	-	-	-	M84.9G
	Matt Silver	-	-	-	M84.9AM
	Matt Gold	M84.3GM	-	-	M84.9GM
	Oak	-	-	-	M84.9WO

Doubledge™ - 14.5mm					
	14.5mm version of the 8.5mm Doubledge.				
	Gold	-	-	-	M81.9G

	Finish	0.90m x 30 Per Carton	0.90m x 40 Per Carton	2.70m x 15 Per Tube	2.70m x 10 Per Tube
Squaredge™ - 8.5mm 	To give a neat square edge against which to butt other floor coverings. Also effective for finishing around French windows or raised thresholds. Fits over edge of laminate. No screws or fixings required.				
	Gold	-	-	-	M85.9G
	Matt Silver	-	-	-	M85.9AM
	Matt Gold	M85.3GM	-	-	M85.9GM
	Oak	-	-	-	M85.9WO

	Finish	0.90m x 30 Per Carton	0.90m x 40 Per Carton	2.70m x 15 Per Tube	2.70m x 10 Per Tube
Squaredge™ - 14.5mm 	14.5mm version of the 8.5mm Squaredge.				
	Gold	-	-	-	M82.9G
	Matt Silver	-	-	-	M82.9AM
	Matt Gold	-	-	-	M82.9GM

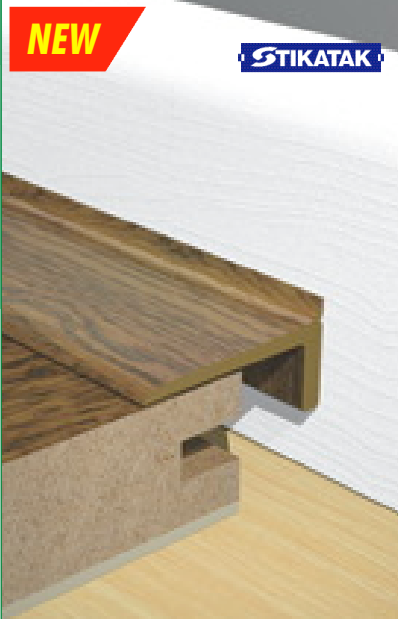
Floor Edge Trims

	Finish	0.90m x 40 Per Carton	2.70m x 15 Per Tube	2m x 2 lengths 10 Per Pack
The Floor Edge 	The new Floor Edge Trim is a patented product which has been designed to bridge the expansion gap between wood / laminate flooring and the skirting. It is self adhesive, easy to fit and sits flat to the floor giving a clean smart finish. Available in 6 colours.			
	Random Slate	-	-	WFT002R
	Silver Blue Slate	-	-	WFT002S
	White Slate	-	-	WFT002W
	Moroccan Stone	-	-	WFT002M
	Oak	-	-	WFT002O
	Light Oak	-	-	WFT002LO
	Available Colours 			

Gripperrods

Stair rods

Beautiful, stylish, simple and secure - stair rods allow you to combine the traditional elegance of individual stair rods with wall-to-wall carpeting or stair runner, then these are for you. Stair rods will add a really distinctive touch to any staircase.

Hollow Stair Rods



Constructed from 16mm quarter round aluminium extrusion with lustrous gold anodised finish.

6062 8 x 3.125m (12' 3")

Brackets



Polished, die cast, solid brass brackets designed for use with item no 6062 hollow stair rods. Hinged top plate to enable easy fitting and securing of rods.

6548 Pack of 10 Pairs

Clip System

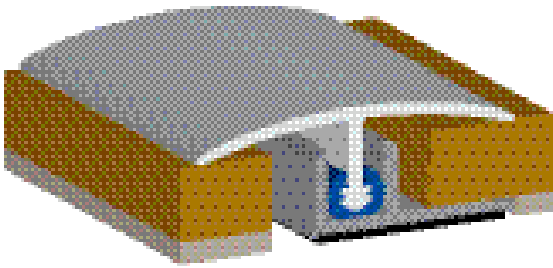

Our Clip System allows the professional floor layer total flexibility in joining floors of any type and of different heights. You can position the profile correctly and remove and replace the profile time after time without damage:

- Wood or laminate and wood or laminate
- Wood or laminate and carpet or carpet tiles
- Wood or laminate and vinyl or lino
- Wood or laminate and ceramic or natural stone tiles
- Only two base sizes are required to accommodate height differences between 8mm and 18mm
- Take up and re-use the top time and time again
- No visible fixings - a perfect and aesthetic finish for the home owner

Available Colours	
Matt Gold	Matt Silver
Oak	Beech
Mahogany	Alder

Clip System Base

Type

2.70m x 20
Per Carton

Clip System Base - 8mm to 13mm

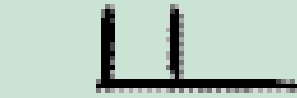

Aluminium base for M42, M43, M44 and M47.

Without Teeth
Without Teeth / Self Adhesive

M46.9-UNP
M46.9UNPSA

Clip System Base - 14mm to 18mm

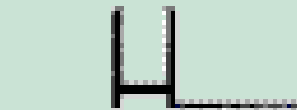

Aluminium base for M42, M44 and M47.

Without Teeth

M41.9UNP

Clip System Profiles

Finish

2.70m x 5
Per Carton

Variable Height - 8mm to 18mm

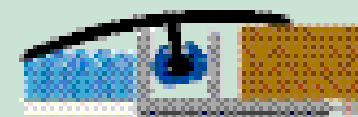

Aluminium top for use with both bases up to a max. height of 18mm

Matt Silver
Matt Gold
Alder
Mahogany
Oak

M42.9AM
M42.9GM
M42.9WA
M42.9WM
M42.9WO

Roundedge™ Small - 8mm to 13mm

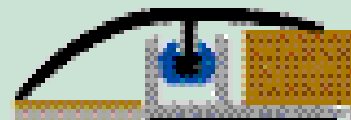

Aluminium top for use with small base up to a max. height of 13mm

Matt Silver
Alder
Beech
Mahogany
Oak

M43.9AM
M43.9WA
M43.9WB
M43.9WM
M43.9WO

Doubledge™ - 8mm to 18mm

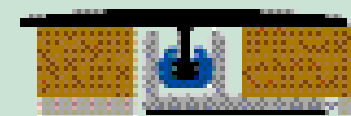

Aluminium top for use with both bases up to a max. height of 18mm

Matt Silver
Matt Gold
Alder
Beech
Mahogany
Oak

M44.9AM
M44.9GM
M44.9WA
M44.9WB
M44.9WM
M44.9WO

Borderedge™ - 8mm to 18mm

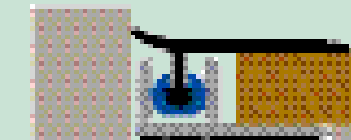

Aluminium top for use with both bases up to a max. height of 18mm

Matt Silver
Matt Gold

M47.9AM
M47.9GM

Stair Nosings & Finishing Products



Our extensive range of Stair Nosings consists of both slimline and heavy duty aluminium profiles available with PVC inserts in a choice of 11 colours and a comprehensive range of PVC nosings, skirtings and cove formers.

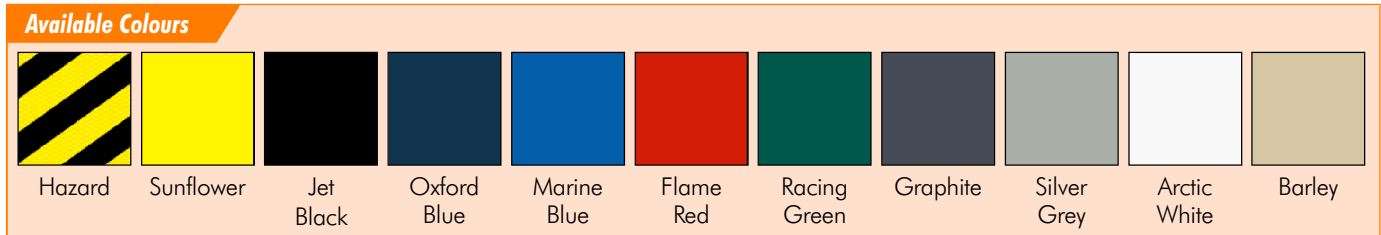
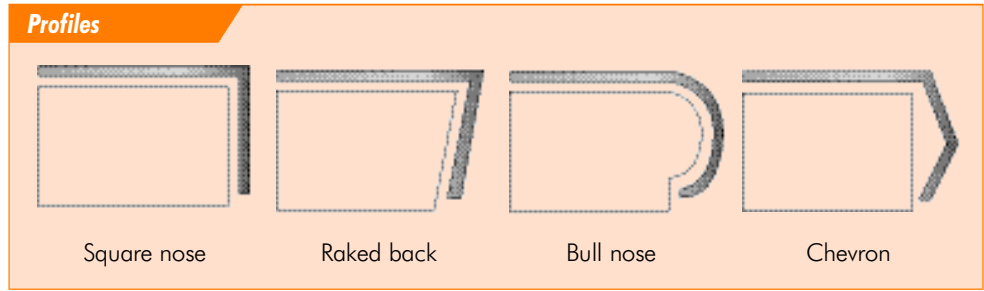

Slimline Aluminium Stair Nosings

Colours Available

3.22m x 20 Per Carton

2.75m x 20 Per Carton

2.44m x 20 Per Carton

Profile Name	For use with vinyl, linoleum and needle punch carpet.	Colours Available	3.22m x 20 Per Carton	2.75m x 20 Per Carton	2.44m x 20 Per Carton
Slimline Single Square Nose 		Full Range	W01322	W01275	W01244
Slimline Square Nose Wide 		Full Range	W012322	W012275	W012244
Slimline Double Square Nose 		Full Range	W09322	W09275	W09244
Slimline Chevron 		Full Range	W02322	W02275	W02244
Slimline Bull Nose 		Full Range	W06322	W06275	W06244

Stair Nosings & Finishing Products

Slimline Aluminium Stair Nosings

Colours Available

3.22m x 20
Per Carton

2.75m x 20
Per Carton

2.44m x 20
Per Carton

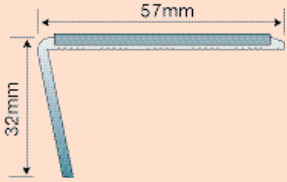
Slimline Single Raked Back					For use with vinyl, linoleum and needle punch carpet.			
	Full Range	W07322	W07275	W07244				

Slimline Double Raked Back					For use with vinyl, linoleum and needle punch carpet.			
	Full Range	W010322	W010275	W010244				

Heavy Duty Aluminium Stair Nosings

Colours Available

3.22m x 20
Per Carton

2.75m x 20
Per Carton

2.44m x 20
Per Carton

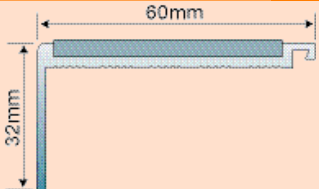
Heavy Duty Single Square Nose					For use with medium-heavy duty carpets, carpet tiles & heavy duty smooth flooring.			
	Full Range	W04322	W04275	W04244				

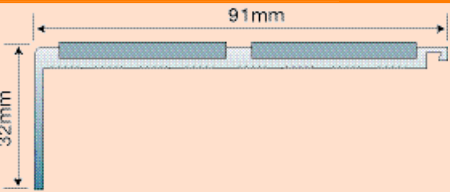
Heavy Duty Double Square Nose					For use with medium-heavy duty carpets, carpet tiles & heavy duty smooth flooring.			
	Full Range	W05322	W05275	W05244				

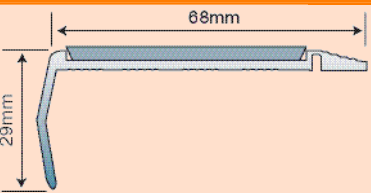
Heavy Duty Single Chevron					For use with medium-heavy duty carpets, carpet tiles & heavy duty smooth flooring.			
	Full Range	W014322	W014275	W014244				

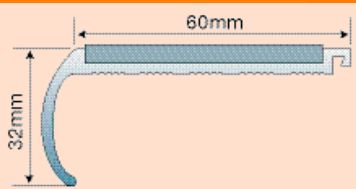
Heavy Duty Single Bull Nose					For use with medium-heavy duty carpets, carpet tiles & heavy duty smooth flooring.			
	Full Range	W08322	W08275	W08244				

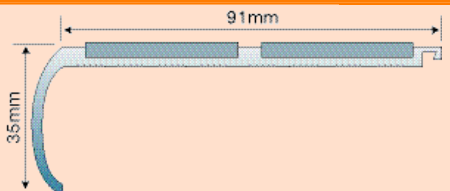
Heavy Duty Double Bull Nose					For use with medium-heavy duty carpets, carpet tiles & heavy duty smooth flooring.			
	Full Range	W011322	W011275	W011244				

Heavy Duty Aluminium Stair Nosings

Colours Available

3.22m x 20 Per Carton

2.75m x 20 Per Carton

2.44m x 20 Per Carton

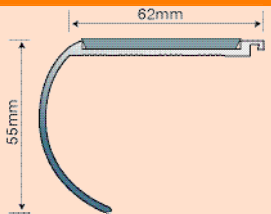
Heavy Duty Single Bull Nose - 55mm Drop		For use with medium-heavy duty carpets, carpet tiles & heavy duty smooth flooring.			
	Full Range	W013322	W013275	W013244	

Heavy Duty Single Raked Back		For use with medium-heavy duty carpets, carpet tiles & heavy duty smooth flooring.			
	Full Range	W03322	W03275	W03244	

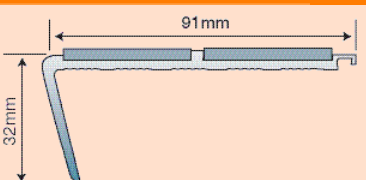
Heavy Duty Double Raked Back		For use with medium-heavy duty carpets, carpet tiles & heavy duty smooth flooring.			
	Full Range	W015322	W015275	W015244	

Interlocking Aluminium Naplock

Colours Available

3.22m x 20 Per Carton

2.75m x 20 Per Carton

2.44m x 20 Per Carton

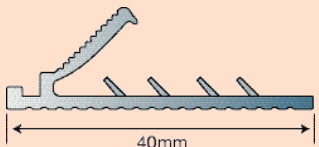
Interlocking Naplock - Spragged		For heavy duty aluminium stair nosings.			
	Aluminium	WNL1322	WNL1275	WNL1244	

Flexible PVC Nosings

Colours Available

3.20m x 10 Per Carton

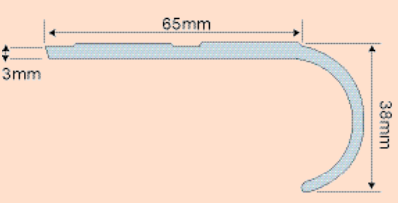
Flexible PVC Nosing - Bull Nose		Easy to use slip resistant stair edging for light traffic areas, easily cut and fixed with contact adhesive (pg 29).	
	Black	WFN1	

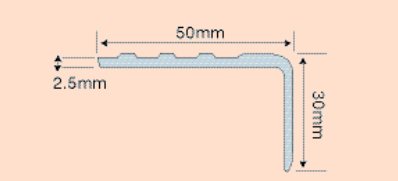
Flexible PVC Nosing - Square Nose		Easy to use slip resistant stair edging for light traffic areas, easily cut and fixed with contact adhesive (pg 29).	
	Black	WFN2	

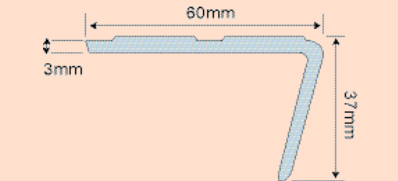
Flexible PVC Nosing - Raked Back		Easy to use slip resistant stair edging for light traffic areas, easily cut and fixed with contact adhesive (pg 29).	
	Black	WFN3	

TOP TIP

Fitting stair nosings using templates/curves

Aluminium stair nosings can be made to fit most irregular shapes and curves. However each curved step must be treated individually and a separate template made for each using card or felt paper. Follow these simple steps as an easy guide to the perfect edge.

Step 1

Place the card or felt on top of the curve that requires a template and draw a line underneath with a felt pen or marker (see fig. 1) following the edge of the curve to create a smooth line



Step 2

Cut the shape along the felt pen mark (fig. 2) and clearly indicate the top and front edge of the template.



PVC Finishing Products



Lok Top

Colours Available

2.50m x 10 Per Carton

Lok Top Ramp Edge

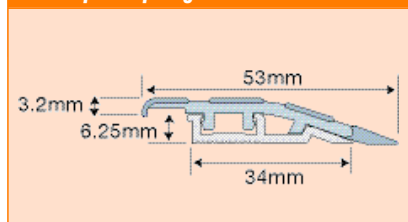

Ideal for use in commercial premises when joining carpet to vinyl, ceramics to vinyl, carpet to carpet.

Black & Silver

WLTT1 - Top
WLTB1 - Base

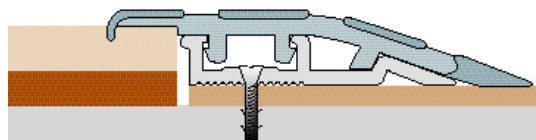

Lok Top Double Edge



Ideal for use in commercial premises when joining carpet to vinyl, ceramics to vinyl, carpet to carpet.

Black & Silver

WLTT2 - Top
WLTB2 - Base

Note:

Base should be fitted on top of the vinyl floor covering. Can be fixed by either screwing or adhering to sub floor (see page 29 for adhesives).

Diminishing Strip

15m x 10 Per Carton

2.00m x 40 Per Carton

Diminishing strip - 4.5mm

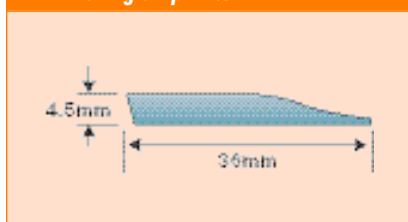

Used to ramp down vinyl, carpets and carpet tiles, preventing trip hazards. Available in black or silver grey. Special colours available on request.

-

WDS45

Diminishing strip - 2.5mm

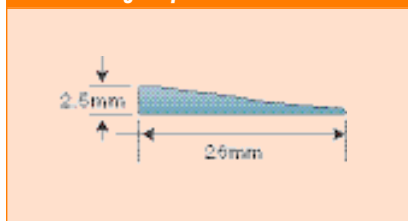

Used to ramp down vinyl, carpets and carpet tiles, preventing trip hazards. Available in black or silver grey. Special colours available on request.

WDS25

-

Diminishing strip - 2.0mm

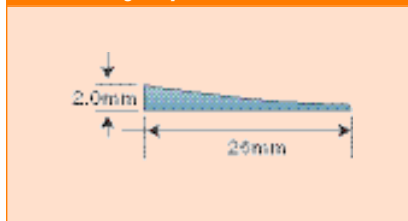

Used to ramp down vinyl, carpets and carpet tiles, preventing trip hazards. Available in black or silver grey. Special colours available on request.

WDS20

-



Diminishing strips are used to ramp down vinyl carpets and carpet tiles to prevent trip hazards.

Flexi Edge

Flexi Edge

Ideal for use with ceramic tiles when forming unusual floor shapes. Stikatak bending machine is also available. Please contact the sales office for details.

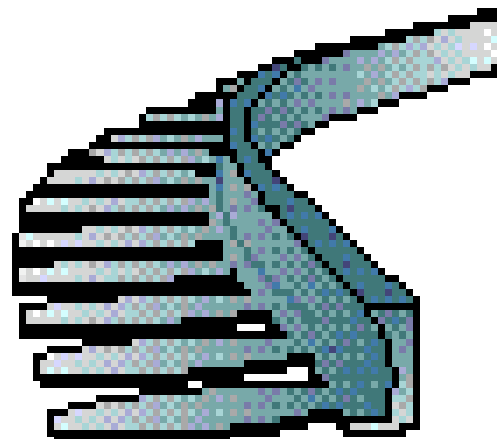

Colours Available

2.5m x 10 Per Carton

6mm	Silver	WFEA06
6mm	Brass	WFEB06
8mm	Silver	WFEA08
8mm	Brass	WFEB08
10mm	Silver	WFEA10
10mm	Brass	WFEB10

Capping Strip

Colours Available

2.00m x 60 Per Carton

Capping Strip Double Lip

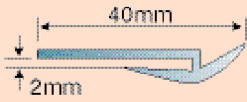

To protect and finish the edge of the floor covering.

Black or White

WCAP1

Capping Strip Single Lip

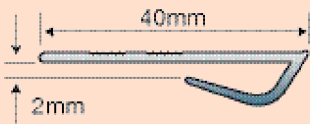

To protect and finish the edge of the floor covering.

Black or White

WCAP4

Capping strip

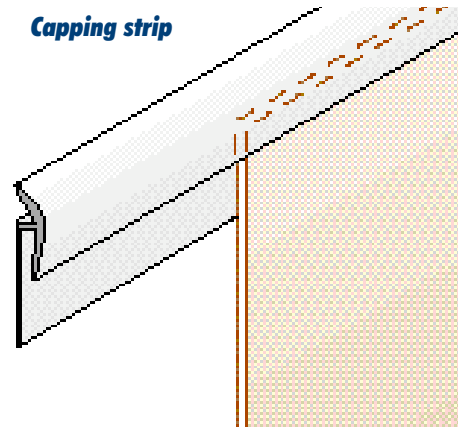

Vinyl To Tile

Colours Available

2.44m x 50 Per Carton

STIKATAK

Vinyl To Tile Single Part

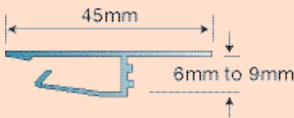

Used to finish and seal vinyl to ceramic tile.

White

WVT1

Vinyl To Tile Two Part

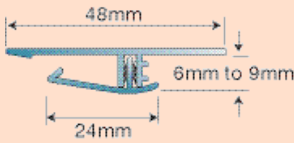

Used to finish and seal vinyl to ceramic tile. User friendly, supplied in two parts for your convenience.

White

WVT2

Vinyl to tile

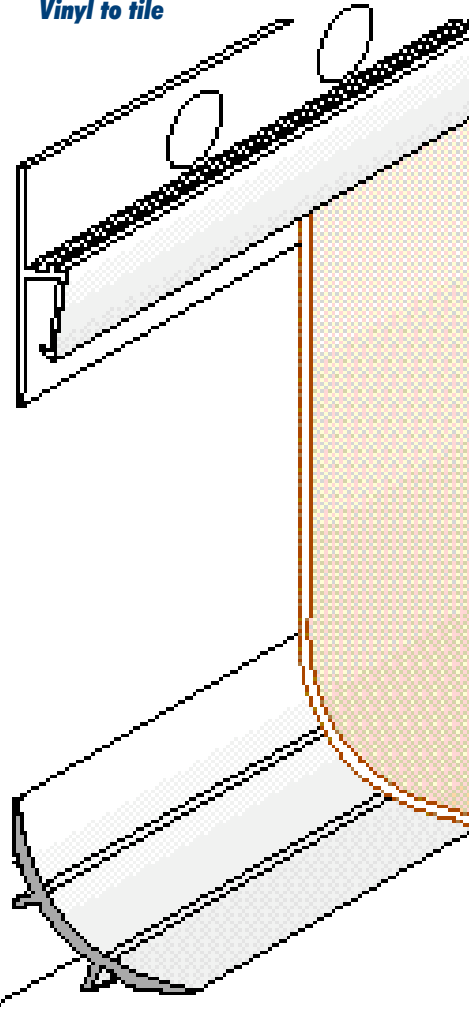

Cove Formers

Colours Available

2.00m x 30 Per Carton

Cove Former - 20mm

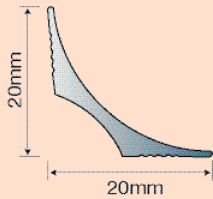

Used to support floor coverings formed from floor to wall.

Black

WCF3

Cove Former - 32mm

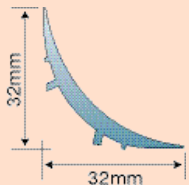

Used to support floor coverings formed from floor to wall.

Black

WCF2

Cove Former - 38mm

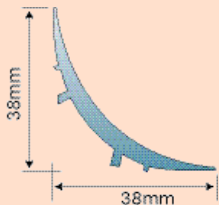

Used to support floor coverings formed from floor to wall.

Black



WCF1

Cove Formers

Stair Edge Trims

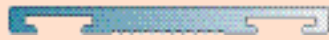

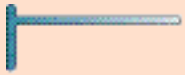
Stair Edge Trim	Size	Per Length
	2.5m Length	WUC25

Stair Edge Trim Inserts	Size	20 Per Carton
 	Two sizes of inserts for stair edge trims.	
WAF1	3.5mm & 8mm	WAF1
WAF2	4.5mm & 7mm	WAF2

Angledge	Type	10 Per Carton
	83°	WUCP83
	90°	WUCP90

Figure. 1

WUC/WAF1

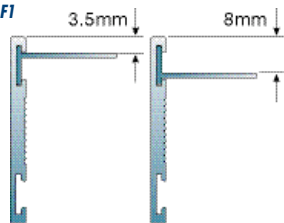
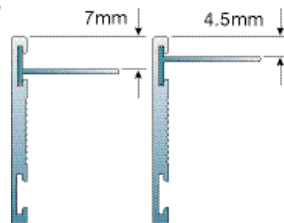

Figure. 2

WUC/WAF2



Stair edge trims are an integral part of an open staircase and are required to protect the edge and floor covering as well as provide a neat and professional finish to the open side.

The adaptable combination of aluminium and PVC is based around flexibility and especially designed with a "lock in" channel section that enables the PVC to glide into the base section and allows the options of size by simply reversing the section.

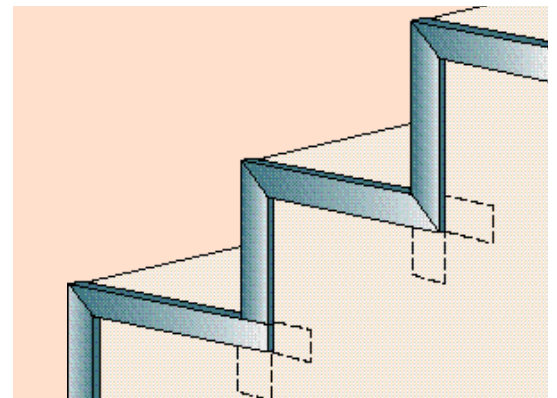

The flexibility becomes one of two choices - 3.5mm and 8mm (figure 1) or 4.5mm and 7mm (figure 2) and because of the unique design the only other choice is 90° or 83° angles, offering sizes that will accommodate most floor coverings. This new stair trim is the ultimate in design and flexibility.



Sit On Skirting

Height

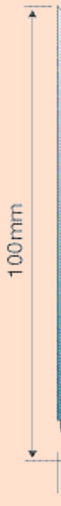
2.00m x 40 Per Carton

Sit On Skirting	Fixed to the wall with impact tape or contact adhesive and on top of the floor covering. Available in Black or Silver Grey.
	150mm WSO150
	100mm WSO100
	75mm WSO75

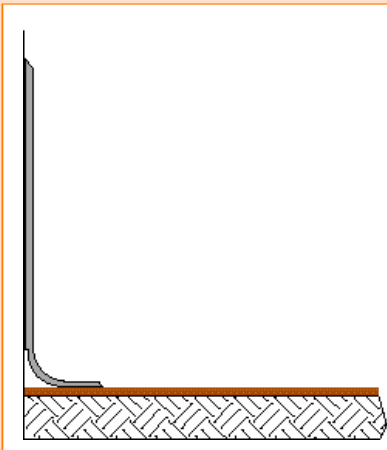
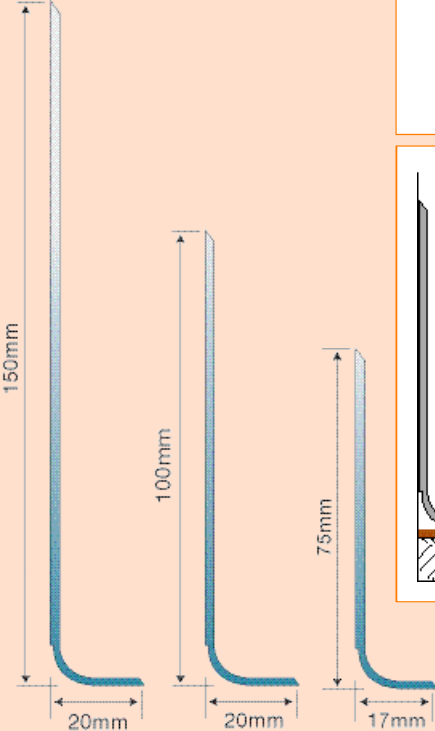
Set In Skirting

2.00m x 24 Per Carton

Set In Skirting - 100mm	Butt jointed to the edge of the vinyl, then seam welded giving the floor a water-tight seam. Available in Black.
	WSE100

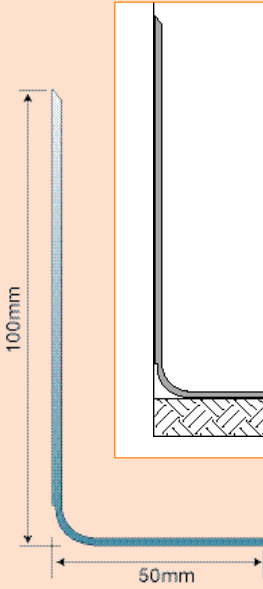

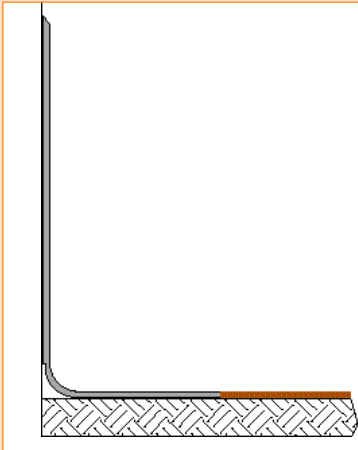
Our adhesives manufacturing plant in Haslingden produces a range of high quality, environmentally friendly, low VOC adhesives and our R&D and Technical teams ensure that our products are suitable for use with the latest trends in floorcoverings and health and safety requirements. COSHH and technical data sheets for all our adhesives are available upon request.

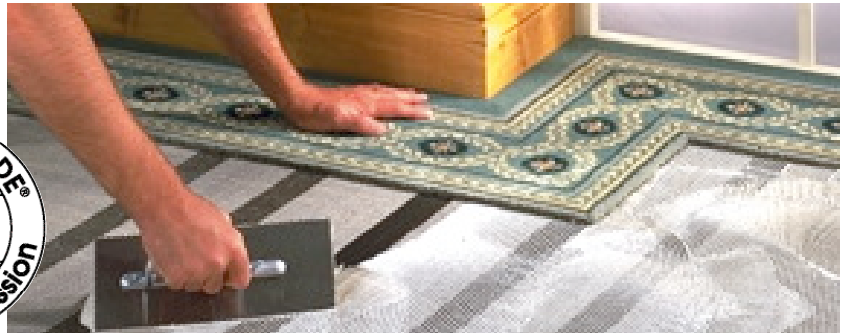
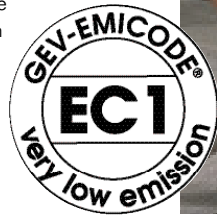

STK 100 - Low Emission Acrylic Flooring Adhesive



STK 100 is a solvent free, high performance water-based acrylic dispersion which has very good bond strength and Low Emissions (EC2)

STK 100 is suitable for:

- Plasticised Vinyl Floorcoverings (including tiles)
- Carpets with PVC, PU, latex, textile and high density foam backings

STK 100 is suitable for use on the following sub-floors:

- Concrete
- Flooring grade hardboard
- Plywood
- Chipboard
- Sand/cement screed
- Proprietary good quality self-smoothing underlayments
- Asphalt & surface membranes. Asphalt & surface membranes should be treated with at least a 3mm coating of smoothing compound (STK 1200 /STK 1300) before applying adhesive (see page 26).

STK100

Pack Size: 15kg
 Coverage: Approx 45 sq mtrs per 15kg
 Storage: 12 months if stored between 5-25°C in a cool dry area, in original unopened containers. Protect from frost
 Open Time: 15 – 45 mins.

STK 200 - Very Low Emission Pressure Sensitive Flooring Adhesive



STK 200 is a high performance, Very Low Emissions (EC1) water-based acrylic dispersion which represents the highest level of environmentally friendly adhesives currently available.

- Pressure sensitive with high tack
- Versatile bonding
- Double stick method for non-porous substrates

STK 200 is suitable for:

- PVC sheet and tiles
- Cushioned Vinyl
- Polypropylene based products
- Smooth rubber up to 2.5mm with sanded backings
- Cork up to 4mm
- Carpets with PVC, PU, latex, textile and high density foam backings

STK200

Storage: 12 months if stored between 5-25°C in a cool dry area, in original unopened containers. Protect from frost

STK 200 is suitable for use on the following sub-floors:

- Concrete
- Flooring grade hardboard
- Plywood
- Chipboard
- Sand/cement screed
- Proprietary good quality self-smoothing underlayments
- Asphalt & surface membranes

If a surface membrane is in place and in suitable condition STK 200 can be applied directly onto it when used as a pressure sensitive adhesive. Otherwise a minimum 3mm coating of smoothing compound (STK 1200/STK 1300) should be applied prior to application of the adhesive (see page 26).

STK 200 also contains both an in-can and dry film preservative.

Pack Size: 15kg
 Coverage: Approx 40-70 sq mtrs per 15kg
 Open Time: Wet: 15 – 45 mins.
 Pressure sensitive when completely dry

STK 300 - Fast Grab Multi-Purpose Flooring Adhesive



STK 300 is a versatile, water-based, synthetic latex, multi-purpose adhesive which has exceptional bond strength, fast grab, is easy to trowel and is non staining

STK 300 is suitable for:

- Double stick applications where a long open time is not required
- Hessian, Actionbac, Needle Punch, Rubber, Felt, Jute, Gel & Latex backed carpets
- Non-Plasticised Vinyl
- Cushioned Vinyl

STK 300 is suitable for use on the following sub-floors:

- Concrete
- Flooring grade hardboard
- Plywood
- Chipboard
- Sand/cement screed
- Proprietary good quality self-smoothing underlayments
- Asphalt & surface membranes. Asphalt & surface membranes should be treated with at least a 3mm coating of smoothing compound (STK 1200 /STK 1300) before applying adhesive (see page 26).

STK300

Pack Size: 15kg
 Coverage: Approx 45 sq mtrs per 15kg
 Storage: 12 months if stored between 5-25°C in a cool dry area, in original unopened containers. Protect from frost
 Open Time: 10 – 20 mins.

STK 400 - Very Low Emission Carpet Adhesive



STK 400 is a solvent-free, versatile, water-based, synthetic latex which is easy to trowel, has fast grab and is non staining. It has Very Low Emissions (EC1), which represents the highest level of environmentally friendly carpet adhesives currently available. It also meets I.M.O. accreditation.

STK 400 is suitable for:

- Double stick applications where a long open time is not required
- Hessian, Actionbac, Felt, Gel & Latex backed carpets
- Non-Plasticised Vinyl
- Cushioned Vinyl

STK 400 is suitable for use on the following sub-floors:

- Concrete
- Flooring grade hardboard
- Plywood, chipboard, sand/cement screed
- Proprietary good quality self-smoothing underlayments
- Asphalt & surface membranes. Asphalt & surface membranes should be treated with at least a 3mm coating of smoothing compound (STK 1200 /STK 1300) before applying adhesive (see page 26)

STK400

Pack Size: 15kg
 Coverage: Approx 45 sq mtrs per 15kg
 Storage: 12 months if stored between 5-25°C in a cool dry area, in original unopened containers. Protect from frost
 Open Time: 10 – 20 mins.

STK 500/525 Very Low VOC Release Tackifier



STK 500/525 is a solvent free, high performance, water based acrylic dispersion, with very low emissions (EC1)

STK 500/525 Is suitable for:

- Preventing the movement of floor coverings in normal traffic areas whilst allowing easy removal when required
- May also be used to permanently bond carpet and carpet tiles in heavy traffic areas

STK 500/525 is suitable for use on the following sub-floors:

- Concrete
- Flooring grade hardboard
- Plywood
- Chipboard
- Sand/cement screed
- Proprietary good quality self-smoothing underlayments

STK500/525

Pack Size: 10kg / 25kg
 Coverage: Approx 5-7 sq mtrs per 1kg
 Storage: 12 months if stored between 5-25°C in a cool dry area, in original unopened containers. Protect from frost

STK 600 - High Performance Flexible Wood Flooring Adhesive

NEW



STK 600 is a high performance, low emission, water and solvent-free, elastic one-component adhesive for wood flooring. It has good resistance to humidity, weathering and temperatures of -40°C to +90°C.

STK 600 is particularly suitable for problematic wooden flooring and can be used over normal underfloor heating systems.

STK 600 is suitable for use on the following sub-floors:

- Concrete
- Flooring grade hardboard
- Plywood
- Chipboard
- Sand/cement screed
- Proprietary good quality self-smoothing underlayments
- Asphalt & surface membranes

If a surface membrane is in place and in suitable condition STK 600 can be applied directly onto it. Otherwise a minimum 3mm coating of smoothing compound (STK 1200/STK 1300) should be applied prior to application of the adhesive (see page 26).

STK600

Pack Size: 15kg
 Coverage: 15 sq mtrs per 15kg
 Storage: 6 months if stored between 5-25°C in a cool dry area, in original unopened containers. Protect from frost
 Open Time: 30 mins.

STK 700 - Contact Adhesive



STK 700 is a brushable solvent-based synthetic rubber resin solution. It is highly versatile and fast drying.

STK 700 is suitable for:

- Wood
- Plastic laminates
- Aluminium
- Rigid PVC
- Linoleum

To:

- Concrete
- Plywood
- Hardwood
- Chipboard
- Some metals
- Vertical surfaces & counter tops

STK 700 is not suitable for use on expanded polystyrene.

STK700

Pack Size: 4 x 5ltr
 Coverage: 12 sq mtrs per 5ltr (depending on porosity)
 Storage: 12 months if stored between 5-25°C in a cool dry area, in original unopened containers. Protect from frost

STK 800 - Latex Seaming Adhesive



STK 800 is a water-based solvent-free natural rubber latex. It is easy to apply by either brush or a suitable applicator when applying a bead of adhesive.

STK 800 is suitable for:

- providing a permanent bond to the edge of a seam on carpets and underlays.
- excellent general purpose adhesive for paper card and fabrics.

STK800

Pack Size: 4 x 5kg
 Coverage: Approx 4 sq mtrs per kg one way, 2-3 sq mtrs per kg two way
 Storage: 12 months if stored between 5-25°C in a cool dry area, in original unopened containers. Protect from frost.

TOP TIP

Handy Glue Wipes

Industrial strength quick and easy-to-use hand cleaning wipes specially formulated to remove glue, paint, ink, grease, grout and oils.



See page 29

Double Stick Adhesives



STK 900 - Double Stick Carpet Adhesive

NEW



STK 900 is a water based rubber / resin adhesive which has a long open time designed to give a permanent bond to a wide range of floor coverings. It has low odour and is easy to trowel. It also meets I.M.O. accreditation.

This product has been specifically formulated for use with double stick systems where a long open time is required and is particularly suitable for use in warm climates.

STK 900 is suitable for the permanent bonding of:

- Carpet to Duralay Durafit, Duralay System Ten, Tredaire Technics and Tredaire Terra Firma underlays
- Not suitable for urethane backed carpets

STK 900 is suitable for use on the following sub-floors:

- Concrete
- Flooring grade hardboard
- Plywood, chipboard, sand/cement screed
- Proprietary good quality self-smoothing underlayments
- Asphalt & surface membranes. Asphalt & surface membranes should be treated with at least a 3mm coating of smoothing compound (STK 1200 /STK 1300) before applying adhesive (see page 26)

STK900

Storage: 12 months if stored between 5-25°C in a cool dry area, in original unopened containers. Protect from frost

Pack Size: 15kg
Coverage: Approx 45 sq mtrs per 15kg
Open Time: Up to 30 mins.

STK 950 - Double Stick Tackifier

NEW



STK950 is a permanently tacky water based acrylic dispersion adhesive which is solvent-free and has a low odour.

STK 950 has been designed to provide a limited bond for the following underlays:

- Duralay Durafit
- Duralay System Ten
- Tredaire Technics
- Tredaire Terra Firma

STK 950 is now packaged in a rectangular bucket for ease of application when applying with a roller.

STK950

Pack Size: 15kg
Coverage: 45-135 sq mtrs per 15kg
Storage: 12 months if stored between 5-25°C in a cool dry area, in original unopened containers. Protect from frost

THE DOUBLE STICK ADHESIVE SOLUTION

With a double-stick system, the dimensional stability of the carpet is considerably improved thanks to the additional weight and horizontal stiffness which results from the combination of carpet and underlay. The end product can be compared with a huge tile, a room-size "macrotile", which unlike conventional tiles is comfortable to walk on, an advantage normally only offered by stretched installations.

An installation which offers the walking comfort and increased protection against wear that stretch fitting offers, and the stability provided by direct sticking is therefore the ideal solution for the fitting of carpets in commercial areas.

HOW THE SYSTEM IS CONSTRUCTED

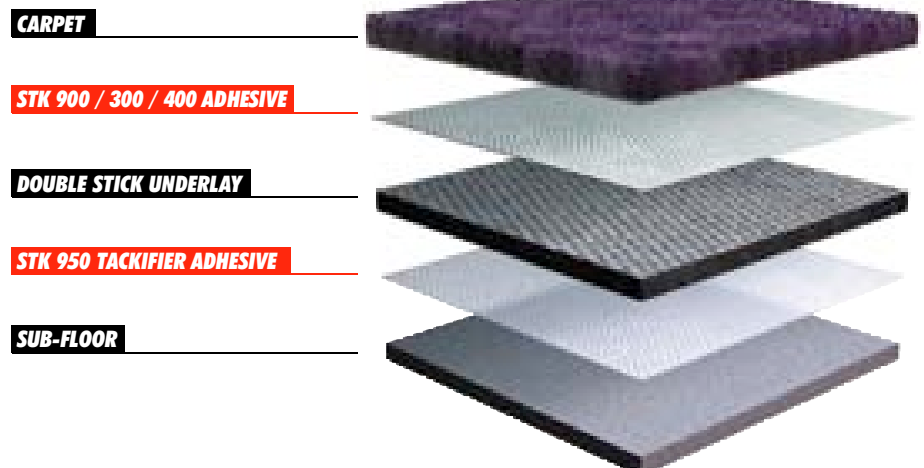

Double Stick Installation Method

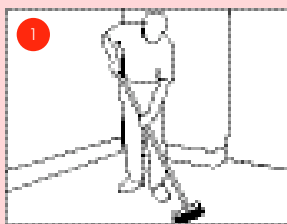

1. The sub-floor must be level, sound, dry and free from dust, grease and other contaminants. It must be free from excessive moisture with a relative humidity not exceeding 75% (in accordance with BS 5325). A moisture indicator test (see page 34) should be performed in all new buildings to check for excessive levels of humidity.

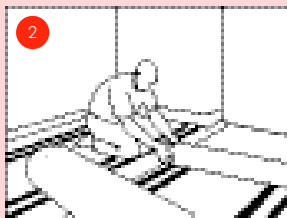

2. Lay out the underlay onto the sub-floor (rubber side down) ensuring seams in the underlay are closely butted and run at 90° to any carpet seams. Check the underlay joins are level and of the same height.



3. Cut the underlay approximately 50mm oversize around the perimeter of the room. Roll back the lengths of underlay to expose the sub-floor.



4. Apply STK 950 tackifier adhesive to the sub-floor using a roller or Tackifier Trowel (see page 35). Once the adhesive has touch dried to a tacky state, roll the underlay back onto the adhesive, ensuring all seams are closely butted. Repeat the procedure for the whole installation. Cut the underlay to approx 6mm from the skirting board or wall to leave a gap for a 'tuck finish'.

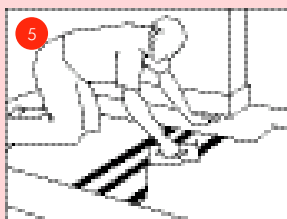

5. Unroll the carpet and manoeuvre into the correct position, cutting approximately to size. Fold the carpet back on itself and apply STK 900 adhesive using a 2mm x 6mm notched trowel (see page 35).

Lay the carpet into this and smooth out any fullness or air bubbles with a Glider (see page 35). Always glide from the centre of the room to the perimeter. Repeat this process for the remaining carpet.

If any seaming of the carpet is required it is important to seal any cut edges with a proprietary seam sealant (STK 800) prior to laying the two sections of carpet into wet adhesive.

Note that heat seaming tape is not required in a double stick installation.

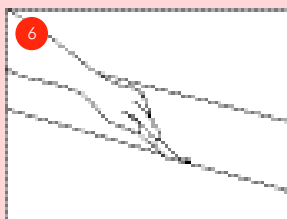
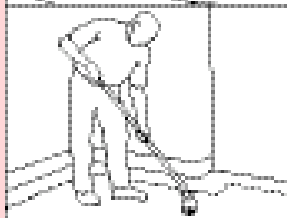

6. The tuck finish around the perimeter may be achieved by cutting the carpet slightly oversize and tucking this into the 6mm gap between the underlay and the wall. When all cutting and seaming is complete, use the glider over the installation again to ensure a perfectly smooth surface and to maximise the bond strength between the carpet and the underlay.

Sub-Floor Preparation

All aspects of sub-floor preparation should be in accordance with the latest version of BS 5325 code of practice for the installation of textile floorcoverings.

Although some of the salient points contained within the Standard are summarised below, the installer should be familiar with the Standard and fully understand the recommendations made therein.

1. Existing floorcoverings such as sheet vinyl, linoleum or any textile floorcovering should be removed and the sub-floor made good prior to commencing with the installation.
2. The sub-floor must be sound, level, dry and free from dust, grease or other contaminants.
3. It is recommended that a moisture indicator test (see page 34) be performed on all new cementitious sub-floors with the installation only proceeding once the relative humidity of the floor has fallen below 75%.
4. A room temperature of at least 18°C and a sub-floor temperature of at least 10°C should be maintained for the duration of the installation. If underfloor heating is present, this should be switched off for 48 hrs prior to and 48 hrs after installation.
5. Uneven surfaces should be smoothed with a proprietary smoothing compound (see STK 1200/STK 1300 page 26).
6. Non-absorbent sub-floors such as ceramic tiles, terrazzo and power-floated concrete slabs should be skimmed with a minimum 3 mm of a proprietary smoothing compound (see STK 1200 /STK 1300 page 26).
7. Very absorbent or dusty sub-floors should be primed with STK 1100 flooring primer (see page 26).
8. Wooden floors must be structurally sound, level, smooth, dry and clean. Wooden floors showing signs of warping, shrinkage, excessive unevenness or wear must be rectified before proceeding. Wax or varnish coatings may react adversely with adhesive and so any such treatment should be removed.
9. Parquet floors must be structurally sound, with any missing or damaged blocks replaced and loose blocks repaired. Again, any wax or glazing treatments must be removed.
10. Metal floors may have a coating of protective grease which should be completely removed. Galvanised steel floors should be primed with STK 1100 flooring primer (see page 26).

Flooring Screed & Primer



STK 1100 - Universal Primer



STK 1100 is a ready to use, water-based polymer, priming and bonding agent.

STK 1100 can be used undiluted for the treatment of internal floors prior to the application of smoothing compounds such as STK 1200/1300

When diluted 1:1 STK1100 will consolidate friable (crumbly) surfaces, reduce porosity and provide improved adhesion.

STK 1100 should also be used to prime STK 1000 (surface DPM) prior to the application of smoothing compounds.

STK1100

Pack Size: 4 x 5kg

Coverage: 50 sq mtrs depending on application

Storage: 12 months, protect from frost

STK 1200 - Water Based Smoothing Compound

NEW



STK 1200 is a water-based cementitious smoothing compound containing specially graded fillers, fine cements and polymers for smoothing and levelling internal floors prior to the application of floor coverings.

STK 1200 is protein free, has easy flow and is suitable for hand or pump application and has a rapid walk on time of 2 hours (depending on ambient conditions). It can receive floorcoverings after 24 hours.

- STK 1200 is suitable for depths from 2mm to 50mm and reaches a compressive strength of 40N/mm² after 28 days

STK1200

Pack Size: 25kg

Coverage: 4/5 sq mtrs at 3mm

Storage: 6 months, protect from frost

STK 1300 - Latex Based Smoothing Compound Powder (Part A)



STK 1300/1350 is a two-part latex based smoothing compound used for preparing and levelling of most interior floors prior to the floor covering installation.

STK 1300 has good self-smoothing properties, covers and adheres to most substrates and has rapid walk on time (2-4 hrs). Must be used in conjunction with STK 1350

- STK 1300 is protein free and can receive floor coverings after 18hrs at a room temperature of 20°C
- STK 1300 can be bulked out up to 50% using 3mm granite chippings and reaches a compressive strength of 21N/mm² after 28 days.

STK1300

Pack Size: 22kg

Coverage: 4/5 sq mtrs at 3mm

Storage: 6 months, protect from frost

STK 1350 - Latex Based Liquid (Part B)

- STK 1350 is the recommended latex liquid to complement STK 1300 powder. It has been developed to give optimum flow at the correct mixing ratio.

STK1350

Pack Size: 4.35 ltr

Retail packaged adhesives

Find our full range of retail packaged flooring adhesives on page 47 of the catalogue.

Flooring Screed & Primer Selector Chart



Substrate

Substrate	STK1100	STK1200	STK1300 STK1350
Concrete	Diluted	R	R
Sand/Cement	Diluted	R	R
Stone	Diluted	R	R
Anhydrite (Calcium Sulphate)	Diluted	R	R
Terrazzo and Quarry Tiles	Neat	R	R
Old Adhesive Residue	N/R	N/R	R
Old Bituminous Residues	N/R	N/R	R
Asphalt	Neat	R	R
STK 1000 DPM	Neat	R	R

KEY:

R = Recommended

N/R = Not Recommended

Moisture Suppression



STK 1000 - Epoxy Damp Proof Membrane

NEW



STK 1000 is an epoxy damp proof membrane which chemically cures to suppress residual construction moisture.

STK 1000 suppresses rising dampness (where no DPM is installed) in concrete and sand/cement screeds.

This permits the early installation of moisture sensitive flooring in fast track building programmes.

STK 1000 suppresses the passage of construction moisture and rising damp up to 90% in one coat and 95% in 2 coats and is coloured blue to aid coverage uniformity.

It is packaged in a unique plastic bucket, with insert containing hardener, to make mixing and storage more convenient.

STK1000

Pack Size: 6.4kg

Coverage: 3-4 sq mtrs per kg 1st coat,
5 sq mtrs per kg 2nd coat
(depending on sub-floor)

Storage: 12 months if stored between 5-25°C in a cool dry area, in original unopened containers. Protect from frost.

Adhesives Selector Chart



Carpets

	STK100	STK200	STK300	STK400	STK500 STK525	STK600	STK700	STK900 Double Stick	STK950 Double Stick
Woven	P	P	P	P				P	
Actionbac	P	P	P	P				P	
Gel Foam	P	P	P	P				P	
Needlepunch			P						
Secondary backed	P	P	P	P				P	
Unitary backed	P	P	P	P				P	
Felt	P	P	P	P				P	
Latex	P	P	P	P				P	
Hessian	P	P	P	P				P	

Underlays

Duralay Durafit									P/R
Duralay System Ten									P/R
Tredaire Technics									P/R
Tredaire Terra Firma									P/R

Carpet Tiles

Bitumen backed		P			R				
PVC		P			R				
Gel backed		P			R				

PVC

Vinyl composition tile	P	P	P	P					
PVC	P	P					V/P		
Cushioned	P	P	P	P					
Coving/Skirting							V/P		

Cork

PVC backed	P	P							
------------	---	---	--	--	--	--	--	--	--

Wood

Block						P			
Plank						P			

Rubber

Up to 2.5mm		P					P		
-------------	--	---	--	--	--	--	---	--	--

KEY: P = Permanent R = Release V = Vertical

Spray & Cartridge adhesives



The Stikatak range of spray adhesives and gripper adhesive cartridges includes Superspray Adhesive, which is the market leading product sold into distributors, contractors and retailers.

We have now added to the Superspray range by introducing a 750ml Superspray Contact Adhesive which has proved extremely popular with contractors when a high strength bond is required for capping, coving, sit-on and set-in skirting.

COSHH and technical data sheets for all our adhesives are available upon request or can be downloaded from the Stikatak web site, www.stikatak.co.uk

Superspray Adhesive



General purpose aerosol adhesive DCM and CFC free for perimeter fixing of felt and foam backed carpets, underlays and tiles. Can also be used with foam, floor lining paper, textiles and fabrics to wood, stone, tiles and concrete (not to be used for expanded polystyrene and vinyls).

S707 500ml x 12 per pack
Coverage: Approx. 3 m² per 500ml

Super Blue (Rapid Set Gripper Adhesive)



Super Blue is a ready to use solvent free, rapid set gripper adhesive which allows carpet to be stretched within one hour. This product revolutionises fixing carpet gripper, metal trims and stair nosings to concrete, wood, chipboard and ceramic floors.

S752 310ml x 12 per pack
Coverage: Approx. 45 linear m per 310ml

Gripper Adhesive



Gap filling synthetic rubber based mastic adhesive for fixing gripper and metal edgings to sub-floors and nosings to stair treads. Bonds most common building surfaces including wood, masonry, metal and some plastics. Can also be used for wall panels, skirtings, cladding and door frames (not suitable for expanded polystyrene).

S7512 310ml x 12 per pack
Coverage: Approx. 12 linear m per 310ml

Superspray Contact Adhesive



Spray Contact Adhesive with a high strength two-way bond and fast tack. Ideal for capping, coving, sit-on and set-in skirting. Variable nozzle can be adjusted to suit differing applications. Designed for fixing wood, carpet upstands, most metals, leather, cork, vinyl upstands, semi-flexible PVC nosings, rubber, textiles, PU foam, rigid 'unplasticised' PVC (not suitable for expanded polystyrene, linoleum and soft 'plasticised' PVC).

S708 750ml x 12 per pack
Coverage: 5-6 sq mtrs per 750ml can/single sided application

Glue Wipes



Industrial strength quick and easy-to-use hand cleaning wipes specially formulated to remove glue, paint, ink, grease, grout and oils.

S290 4 x 100 wipes

Vinyl Spray Adhesive



Vinyl Spray Adhesive for temporary or permanent bonding on most surfaces including vinyls (not to be used for expanded polystyrene).

S730 250ml x 12 per pack
Coverage: Approx. 1.5 m² per 250ml

Heat seaming tapes - Heatac™

Gripperrods

Gold Line



Conventional woven or secondary jute backed carpets and Action-Bac

Our top of the range tape is recommended for use in high traffic areas. Instead of the regular crepe paper backing it features a metallised gold foil that offers additional installation benefits:

- Reduces heat loss into the floor, giving a faster adhesive melt rate when the iron is applied and a faster seaming speed if required
- Slows down the adhesive cooling rate, allowing more working time for pattern matching.
- Allows better control at lower temperatures for sensitive carpet piles and backings

6736B 20m x 10 Per Carton

Manufactured in our UK factory in a quality controlled environment, which ensures the very high standards that have made Gripperrods the market leader in this product sector.



All tapes feature a woven scrim with a glass fibre weft and a polyester warp. The glass fibre gives maximum strength across the seam, with no stretch, the polyester allows some stretch along the length. The scrim is stitched to the paper backing to ensure stability. The potential strength of the tape in the finished seam will depend on the density of glass fibre weft (stitches per inch in the scrim), the formulation of the adhesive and the amount of adhesive.

We offer a range of different specification tapes to suit your various requirements. All are designed to give a strength of finished seam in excess of British Standards. The finished seam strength will also depend on selecting the right tape for the job and using the best of tools.

For recommended equipment, See Page 40.

Seamwell

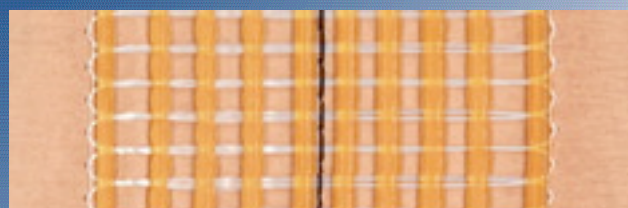

Conventional woven or secondary jute backed carpets and Action-Bac

This tape offers an adhesive formulation and weight designed for high traffic installations and particularly for more difficult backings such as Action-Bac. The adhesive system is designed specifically to achieve good overall contact with these more rigid, uneven textured backings.

6734B 20m x 10 Per Carton

6735B 100m x 2 Per Carton

Standard Gold



Conventional woven or secondary jute backed carpets

A lower cost alternative to Gold Line tape.

It offers the same installation benefits but is designed for light traffic areas only.

6730B 20m x 10 Per Carton

Seamwell Flat

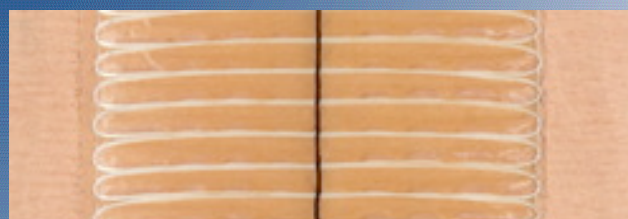

Conventional woven or secondary jute backed carpets and Action-Bac

This tape is designed for the same heavy wear areas and difficult backings as Seamwell but is for those installations where a flat adhesive profile is preferred.

6727B 20m x 10 Per Carton

6728B 100m x 2 Per Carton

Multiline

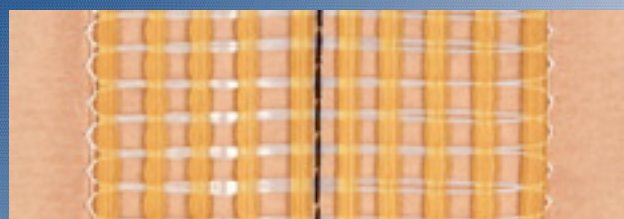

Conventional woven or secondary jute backed carpets

Designed for traditional backed carpets installed in moderate traffic areas.

6712B 20m x 10 Per Carton

6713B 100m x 2 Per Carton

Standard



Felt backed carpet, conventional woven or secondary jute backed carpets

This tape is designed for use in the fitting of felt backed carpets. The lower melt temperature of the adhesive prevents damage to the carpet backing.

The ribbed adhesive profile is designed specifically for use with the THS002 Super Heat Seam Iron. (See Page 40 for details).

This enables the tape to be centred automatically and ensures that the exact amount of adhesive is delivered for seam sealing.

This tape also provides a lower cost alternative to Multiline tape for seaming conventional woven or secondary jute backed carpets in light traffic areas.

6702B 20m x 10 Per Carton

Contract

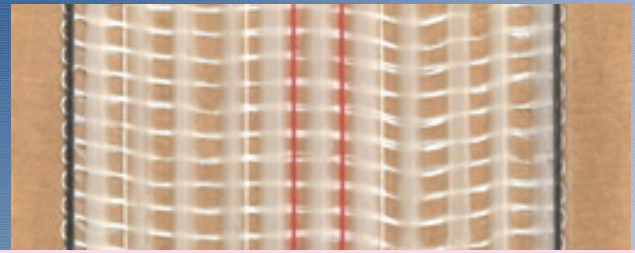

Contract Seaming Tape

A heavy duty heat bond tape recommended for use in high traffic areas.

Scrim is held in place by adhesive rather than stitched paper backing.

H11-25 25m x 8 Per Carton

H11-100 100m x 2 Per Carton

Technical detail and recommended use guide

Gripperrods

Cat. No.	Stitches Per Inch	Backing Type	Adhesive and Profile	Jute	Woven	Poly-propylene	Felt Back
6736B	6-7	Foil	Supreme Ribbed	H	H	H	NR
6734/5B	6-7	Crepe Paper	Supreme Ribbed	H	H	H	NR
6727/8B	6-7	Crepe Paper	Supreme Flat	H	H	H	NR
6712/3B	5-6	Crepe Paper	Standard Ribbed	M	M	NR	NR
6730B	3-4	Foil	Standard Ribbed	L	L	NR	NR
6702B	3-4	Crepe Paper	Super LT & Special Rib	L	L	NR	M
H11-25/100	7-8	Crepe Paper	Contract Ribbed	H	H	H	NR

Caution: In some cases of secondary backings and heat set yarns, the heat transfer from seaming can cause delamination and/or pile reversal. If in doubt, a sample test should be carried out prior to installation.

KEY: **H** = High Traffic **M** = Moderate Traffic
L = Light Traffic **NR** = Not Recommended

Silvaseam Tape



Conventional woven contract and domestic carpets

Designed for use with the THS007 Silvaseam Machine (see Page 40) or similar compatible designs.

An alternative to conventional heat seaming, this top of the range system can be used for seaming 10m of carpet at a time. Longer seams can be made quickly & efficiently by the use of Silvaseam Probes & Plates (THS007P). Benefits of the system include:

- No iron, enabling the fitter to use both hands for pattern matching
- Adhesive can be re-melted to remake seam if required

2000 50m x 5 Per Tub

Heat seaming tools

For our full range of heat seaming installation tools go to page 40 of the catalogue



STIKATAK
Grooming Roller

Gripperrods
Heat Seam Iron Grooved

Double sided tapes

Gripperrods **STIKATAK**

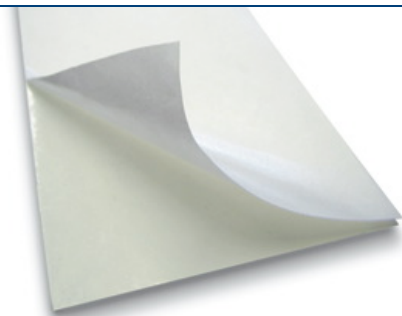

We are pleased to offer a comprehensive range of tape systems:

- Double sided pressure sensitive tapes for every floor covering requirement, including display packed products
- Single sided underlay tapes
- Specialist composite tapes for the tension fitting of felt backed carpets
- Vapour barrier tapes for wood/laminate underlay
- Double sided PMR contact tape for fixing covings and upstands

Gripperrods Premier double sided tapes

	50mm x 50m 5 Per Carton	50mm x 50m 20 Per Carton	50mm x 50m 36 Per Carton	50mm x 25m 5 Per Carton	48mm x 50m 12 Per Carton	48mm x 25m 12 Per Carton	38mm x 50m 48 Per Carton
Premier Gold	6492P	-	-	-	-	-	-
A contract grade double sided tape with a very heavy coating of aggressive synthetic rubber resin adhesive and easily tearable woven cotton carrier, providing high initial tack and subsequent bond strength. Flexible and conformable to all floor surfaces. Excellent gap fill and adhesion to heavily textured carpet backings. Suitable for installing rubber, foam-backed carpets, traditional, polyurethane and woven polypropylene backings.							
Premier Silver	6493P	-	-	-	-	-	-
A heavy domestic grade tape with a high coating of synthetic rubber resin adhesive on a woven cotton scrim and siliconised kraft paper liner which can be easily removed. Flexible and conformable to all floor surfaces. Good gap fill and adhesion to textured surfaces. Suitable for foam-backed and polyurethane backed carpets.							
Premier Bronze	6494P	-	-	-	-	-	-
A medium duty carpet tape with a thin film carrier and outstanding tack and adhesion. Suitable for flat, even subfloors. No ridges or tramlines on thin floor coverings. Suitable for use with carpets and carpet tiles.							
Premier Green PMR	-	-	-	6495P	-	-	-
A high technology product formulated from a special adhesive system to withstand the rigours of plasticiser attack. Specified by many manufacturers of PVC backed textile and PVC resilient floor coverings.							

STIKATAK

Double sided tapes

	50mm x 50m 12 Per Carton	50mm x 50m 20 Per Carton	50mm x 50m 36 Per Carton	36mm x 25m 12 Per Carton	48mm x 50m 12 Per Carton	48mm x 25m 12 Per Carton	38mm x 50m 48 Per Carton
Heavy Duty Cloth Tape	-	B3-50/50	-	-	-	-	-
A high quality cloth carrier with a heavy spread of white coloured hot melt adhesive. The release paper is an easy release silicone paper. Can be used on all types of floorcoverings excluding Vinyl Sheet and Tiles and any product that has plasticiser in its backing.							
Vinyl Tape	B4-50/50	-	-	-	-	-	-
A quality double sided tape produced specially for vinyls and floorcoverings with plasticisers in their backings. The adhesive used on this product is acrylic based to aid the prevention of plasticiser migration caused by an adverse reaction between the adhesive and the floorcovering backing.							
General Purpose Tape	-	-	-	B5-36/25CB	-	-	-
A narrow width 36mm, hot melt coated, economic general purpose tape for use with all surfaces except vinyl.							
Carpet Tape	-	-	-	-	B8-48/50CB	B8-48/25CB	-
A highly aggressive double sided tape, hot melt coated with a paper carrier, for use with carpets other than vinyl backed.							
Printed Exhibition Tape	-	-	B7-50/50	-	-	-	B7-38/50
A unique quality tape specially designed to peel up from a surface without leaving a residue of adhesive. Simple and easy to use with light but aggressive adhesion. Recommended by major exhibition centres such as NEC at Birmingham and Earls Court, Olympia and the Excel centre in London.							

Double sided contact tape (PMR)

Gripperrods

The Gripperrods range of contact tapes are Plasticiser Migration Resistant (PMR) for the rapid and trouble free application of flexible vinyl and other dimensionally stable, smooth backed upstands to a variety of wall surfaces (plaster, concrete, ceramic tile, wood, metal).

The specialist properties of the tape are:

- A construction grade impact adhesive coating giving a fast tack, high strength two way bond
- The PMR properties of our adhesive make this tape the only recommended application method for soft PVC coverings and upstands.
- A very fine web carrier that leaves no ridges or tramlines when applying thinner materials
- A white easy release liner
- It can be applied precisely to the surfaces required without any overspray, unlike wet adhesives
- It is low odour and non-hazardous in normal use
- It is available in three widths to suit all heights of upstand

Contact Tape



Double Sided Contact Tape 25mm

6470P 25mm x 50m 5 Roll Box

Double Sided Contact Tape 50mm

6471P 50mm x 50m 5 Roll Box

Double Sided Contact Tape 85mm

6472P 85mm x 50m 5 Roll Box

See also the new Stikatak Superspray Contact Adhesive for application of hard PVC coverings and cappings on Page 29.

Felt back carpet tapes

STIKATAK

Mushroom tape fixes felt backed carpets

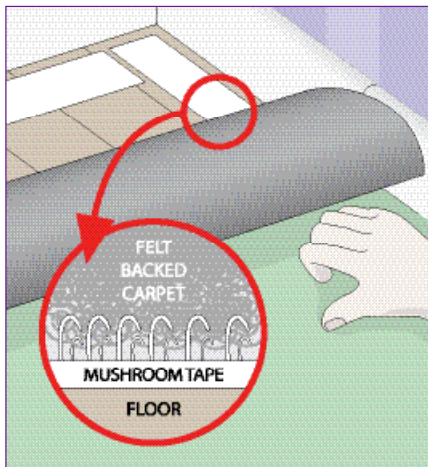

Mushroom Tape



BF10 50mm x 10m 20 Roll Pack

BF25 50mm x 25m 10 Roll Pack

Single sided tapes

STIKATAK

50mm x 50m
24 Per Carton

Water Proof Cloth Silver **C2-50/50-7**

A good quality single sided tape for joining underlay in stretch installations.

Water Proof Cloth Black **C2-50/50-2**

A good quality single sided tape for joining underlay in stretch installations.

Vapour barrier/tape

Gripperrods



75mm x 25m
24 Per Carton

Vapour Tape **6450**

A self adhesive seaming tape for use with Timbermate Excel, Silentfloor Gold and Boardwalk Underlays. The tape creates a vapour barrier and strengthens underlay joins.



250mm x 50m
Per Roll

Vapourstop Sealing Strip **6929**

Creates a new moisture resistant sub floor when used with Timbermate Excel or Silentfloor Gold underlays for wood and laminate floors.

Tools, Blades & Fixings



The new Interfloor tool range has been compiled by choosing the very best of the Gripperrods and Stikatak products, enabling us to offer a comprehensive portfolio of quality tools for use by the professional flooring installer.

Floor stripping and preparation

Hand Scraper

Gripperrods

Robust scraper with soft comfortable grip, suitable for all kinds of stripping on floors and walls. The blade is set at an angle for maximum efficiency.

TSP001

Spare blade (10 pieces) **TSP001A**

Super Carpet Clamp

Gripperrods

Designed to assist the installer when removing stuck down materials from a sub floor. Powerful jaws operate on the lever system - the harder they are pulled, the tighter they grip. Can be used on all types of floor covering.

TSP003

Protimeter Mini Moisture Indicator

STIKATAK

Measurement range and interpretation

The Protimeter Mini Moisture Indicator measures the moisture content in wood from 6% - 28%.

In other non-conductive materials it measures the WME value up to 28%.

The full measurement range is 6-90 but values over 28 are relative.

NR93250

Long Handled Floor-Scraper

Gripperrods

A very stable and heavy duty floor scraper, ideal for removing all types of adhered floor covering.

Length: 1.53m (5').

TSP002

Spare blade (1 piece) **TSP002A**

Carborundum Stone and Handle

Gripperrods

A 20cm x 10cm grinding stone with a D-shaped handle which allows the installer to work more quickly and efficiently to remove trowel marks or high spots from screeds.

TSP007

Tack and Moulding Lifter

Gripperrods

Manufactured from high carbon forged steel, ideal for removing gripper, metals or timber mouldings. Notched at both ends for removal of tacks and nails.

TSP010

Wood measurement

Percentage scale (from 6 to 100%)

Humidity limits

Frame:	18% to 22%
External carpentry:	17% to 18%
Inside carpentry:	14%
Wooden floors:	14%
Cabinet work	6% to 12%

25cm Probes
For deep measures **NR93252**

Adhesive and screed applications



Tackifier Trowel

Gripperrods

Unique notch dimensions specifically designed for STK500, STK525 and STK950 tackifiers, with a beech handle. Notches 5mm depth x 20mm centre, with 1mm notch.

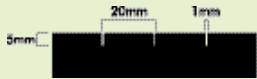

TAS017P Box of 5



Adhesive Trowel B1 Notching

Gripperrods

Traditional tempered steel trowel, notched four sides with hard wood handle. Notches 1.5mm deep x 5mm centres.

TAS007P Box of 5



Spare blade B1 notching
Box of 10 **TAS007B1P**



Adhesive Trowel B2 Notching

Gripperrods

Traditional tempered steel trowel, notched four sides with hard wood handle. Notches 2mm depth x 6mm centres.

TAS008P Box of 5



Spare blade B2 notching
Box of 10 **TAS008B2P**



Screed Trowel

Gripperrods

Traditional tempered steel trowel with hard wood handle.

TAS001P Box of 5



Wood Adhesive Trowel

Specifically designed for the application of wood adhesive

7mm notched trowel

N9006 Box of 12



Adhesive Applicator Gun

Gripperrods

For use in the application of cartridge based adhesives.

TAS010



TEC 3200 Hot Melt Glue Gun

Gripperrods

A heavy duty Hot melt Glue Gun, TEC 3200, which uses 43mm x 50mm Glue Cartridges. This gun is used by professional floorcovering contractors where extensive gluing is required on site with materials such as gripper, metal edgings and nosings.

NJ34

43mm Glue Cartridge 5kg
NJ25



TEC 700 Hot Melt Glue Gun

Gripperrods

A lighter, cheaper, Glue Gun, TEC 700, which uses Glue Sticks and is ideal for the professional installer where small quantities of adhesive are required in domestic and contract situations.

NJ31

Glue gun Stick 5kg
NJ30



Glider

Gripperrods

A heavy metal glider for ensuring perfect adhesion of underlay to sub floor and floor coverings to underlay backing in stick down installations.

TAS013



Applicator Bottle

Gripperrods

This handy 8oz dispenser bottle enables the installer to apply adhesives quickly and accurately.

Pack of 10 Bottles

TAS009B

Flooring Adhesives

For our full range of flooring adhesives go to page 21 of the catalogue.

Cutting & trimming

Trim Master

STIKATAK



Designed by master fitters for professional use, the unique design of the Trim Master ensures a precise cut together with a professional finish when trimming carpet or vinyl.

Trim Master is extremely light in weight and comfortable to hold resulting in greater accuracy and precision. Adjustment to both the

angle and the depth of the blade is extremely easy and Trim Master also allows long lengths of the floor covering to be trimmed both accurately and easily.

Standard Stikatak hooked or straight blades can be used easily and quickly fitted.

N2100 Pack Size: 6

Spare blade N24

Loop Pile Cutter

STIKATAK



A very versatile carpet cutter. Cuts from front or back of carpet with two blade positions. Adjustable stainless steel nose plate allows row tracking and cutting for any depth of pile.

NR91655

Spare blade NR192105

Dolphin Knife

Gripperrods

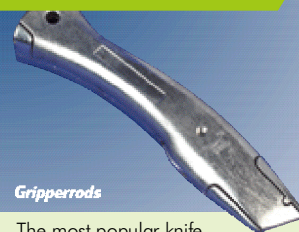

The most popular knife. Comfortable, positive grip. Easy blade replacement with thumbscrew opening, integral blade holder and magnetic blade retainer to hold blade in place whilst closing and locking. Supplied with belt clip and holder.

TCT001

See chart for blades (pg 37)

Lino Knife / Tucker

Gripperrods



For those who prefer the traditional tucker, this must be the best one around. Thick resilient blade. Comfortable rubberised handle.

TST008

Door Trimmer Kit

STIKATAK

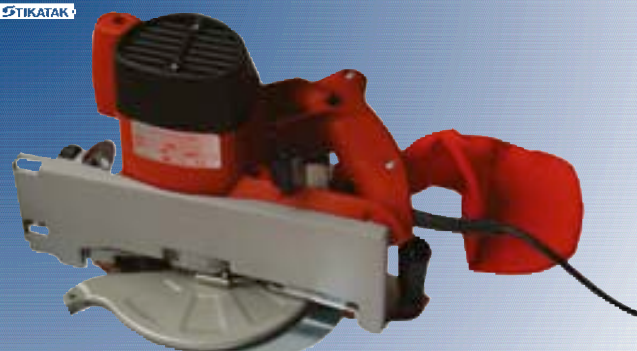

A heavy duty professional door trimmer ideal for the cutting of doors, door frames and skirtings. For cutting at angles of 90° and 45°. Includes 5 spacers for height adjustment. Can be used as a standard wood saw.

Specifications:

Power: 1200W - 230V

Speed: 5000rpm

Maximum cutting depth: 50mm

Cutting height: 7mm to 38.5mm

Weight: 4.7kg

N2200

Spare blade N2201

Small Napping Shear

Gripperrods



Wide blade, blue cushion grip handle, for fast trimming. Now with enlarged finger ring.

TCT012

Large Napping Shear

Gripperrods

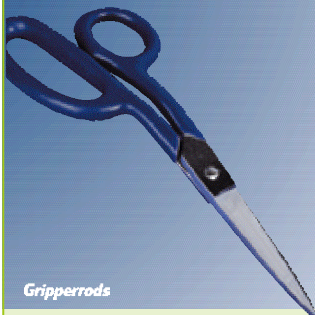

Offset blue cushion comfort grip handle with large bottom ring to minimise hand and wrist fatigue.

TCT013

Super Carpet Shear 10"

Gripperrods



Blue cushion grip handle and durable knife edges ensure easy cutting of textile floor coverings.

TCT014

Super Carpet Shear 12"

Gripperrods



Blue cushion grip handle and durable knife edges ensure easy cutting of textile floor coverings.

TCT015

Cutting & trimming

Gripperrods

Lightweight Carpet Shear 10"



Gripperrods

A 10" lightweight shear pressed from stainless steel with comfortable, large ring handles.

TCT017

Gripper Shears



Gripperrods

Ideal for fast accurate cutting of wooden gripper to fit the contours of any room. The anvil blade provides a firm base on which to rest the gripper when cutting. Moulded, plastic coated handles for a firm comfortable grip.

TCT018

Scotia Cutters / Gripper Mitre Shears



Gripperrods

High quality gripper shears with mitre guide for accurate cutting to any angle.

NW001 Box of 6

Metal Snips



Gripperrods

Built with powerful leverage to provide effortless metal cutting. Well designed, vinyl covered handles assure comfort and protection.

TCT020

Blades, nails & screws

Gripperrods **STIKATAK**

Nails & Screws



Gripperrods

- 6762P** Concrete nails 18mm, Pack of 5 x 1kg tubs
- 6763P** Concrete nails 25mm (1"), Pack of 4 x 1kg tubs
- 6772P** Ring shank pre-nails 18mm, Pack of 4 x 1kg tubs
- 6786P** Blue tacks 25mm (1"), Pack of 20 x 0.5kg boxes
- 6791P** Zinc screws 25mm (1"), Pack of 4 x 1kg tubs
- 6793P** Brass plated screws 25mm (1"), Pack of 4 x 1kg tubs

Heavy Duty Blades

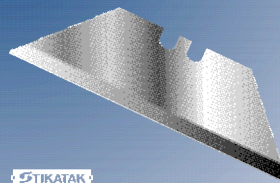

STIKATAK

- N21** Pack Size: 2000
- N22** Pack Size: 500

Use with: **TCT001**

Hooked Blades

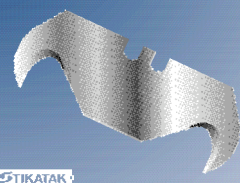

STIKATAK

- N24** Pack Size: 500

Use with: **TCT001, N2100**

Super Hooked Blades

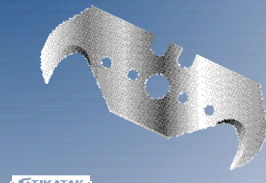

STIKATAK

Pack Size: 10 Dispensers of 10 Blades

NR92230

Use with: **TCT001, N2100**

Loop Pile Cutter Blades

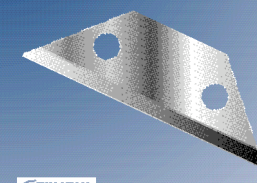

STIKATAK

Pack Size: 10 Dispensers of 10 Blades

NR192105

Use with: **NR91655**

Concave Blades

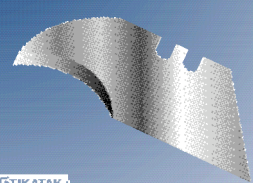

STIKATAK

- N25** Pack Size: 500

Use with: **TCT001, N2100**

Measuring, marking & fixing

Gripperrods

STIKATAK

7.5m Heavy Duty Tape Measure



A 7.5m heavy duty tape measure with Rubber outer case and plastic inner case. It has both Imperial and Metric measurements and a locking device.

NJ23A Box of 24

10m Heavy Duty Tape Measure



A 10m heavy duty tape measure with Rubber outer case and plastic inner case. It has both Imperial and Metric measurements and a locking device.

NJ24A Box of 24

Roll Up Straight Edge 2.1m

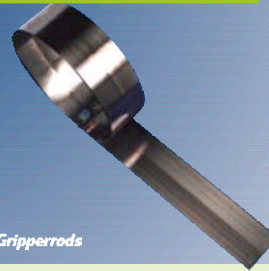

Gripperrods

Flexible steel rule manufactured from 0.5mm thick flat steel. Can be rolled up by using the clip fastener provided.
Length: 2.1m (6'10")
Width: 80mm (3 3/16")

TMM003

Roll Up Straight Edge T-square 4.1m



Gripperrods

The rule is made from creased, 0.5mm tempered steel. The head (600mm x 40mm x 5mm) is attached firmly at 90° using the knurled screw clamp.

TMM004

Chalk Line & Reel



Allows the installer to make accurate and distinct marking on floor covering prior to cutting.

NR93310

Chalk refill, white.
225g bottle **TMM001A**

Electric Staple Gun



Heavy duty staple gun for use in both domestic and contract situations. This tool is highly balanced and ergonomically designed for continuous fastening tasks.

NJ191

Divergent Point Staples
18mm (10x1000) **NJ9118**
22mm (10x1000) **NJ9122**

Tack Hammer 6-10mm



STIKATAK

Designed specifically for stapling underlay to timber floors with ease and speed. Only four moving parts, with good balance and comfortable vinyl hand grip. Rear loaded magazine holds 150 staples.

NJ51

Staples 8mm **NJ54**
Pack 5000

Hand Tacker 6-14mm



STIKATAK

Powerful tacker for use with a range of staple sizes.

NJ53

Staples 8mm **NJ54**
Staples 10mm **NJ55**
Staples 12mm **NJ56**

Awl



Gripperrods

Traditional design for ease of use and durability. Varnished hardwood handle and forged steel point.

TFX010

Magnetic Tack Hammer



Gripperrods

Standard tack hammer with steel shaft, comfortable rubber handle grip, tack removal claw and a magnetised head.

TFX005

Tapping Block

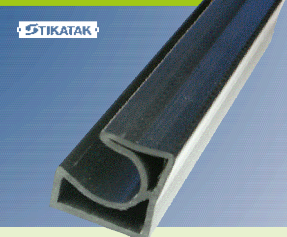

STIKATAK

The new Stikatak Tapping Block has been designed by master floor fitters for ease of use. It is larger and heavier than a traditional tapping block, meaning that it will not slip under the section of laminate flooring when in use.

NW002 Pack of 6

Pulling Bar



STIKATAK

Used when laying Wood or Laminate flooring and panels have to be pulled together.

NW003 Pack of 6

Swivel-Lock Power Stretcher

Gripperrods



- Built in swivel lock. The head has a 60° range of free swivel for stretching patterned carpet. By depressing the built-in lock pin, you can lock the swivel in five convenient positions. Lock in the straight position for square stretching or at 15° for most angle stretching. There's even a 30° setting for extreme angles found in L-shaped rooms
- Adjustable locking power head. Just a touch with your finger and the power head locks in place to allow you to take partial stretches. Gives you complete control over the amount of stretch applied
- Speed roller rail block. A unique 14" wide tail block that is equipped with wheels to run along the skirting. Also features tension control on the tail block to aid control
- Pin adjustment bar. Set-up the pin depth exactly to suit each installation

Comes complete with three extension tubes, auto lock tube and one transfer tube. These make up to 7m maximum length.

TST001

TST003 Corner Support For Swivel-Lock Power Stretcher

A power stretcher is a big investment for any installer. Rather than have a basic stretcher at the lowest price, it must be worth spending more for the most versatile stretcher around. We are pleased to offer the Swivel-Lock Power Stretcher.

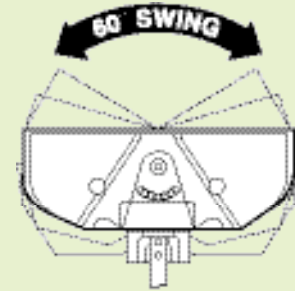

60° of free swing for pattern matching.

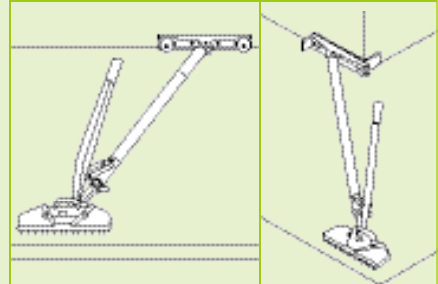

15° locks parallel to wall for normal angle stretches.

30° lock for extreme angles found in living rooms or dining rooms.

Super Knee Kicker

Gripperrods



This knee kicker features the widest head, the largest bumper pad and one of the longest extensions of any kicker on the market. This combination allows you to move one third more carpet with every kick. The rubber hand grip and large rubber bumper pad also make this the most comfortable kicker to use. However, the big secret is in the head. Unique, hardened stainless steel teeth replace the traditional pin plate. These allow vastly improved bite into the carpet with negligible clogging up with yarn fibre. It has simple extension and tooth depth adjustment

TST005

Conventional Knee Kicker

STIKATAK



Our standard extendable knee kicker is of robust precision die-cast construction, with an easy extension mechanism, three Nap Grip inserts and adjustable pin plate with hardened steel pins. Pin depth is easily but precisely adjusted by turning the dial. Moulded buffer pad.

NJ42

Lino Knife/Tucker

Gripperrods

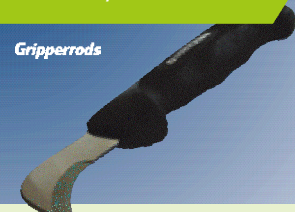

For those who prefer the traditional tucker, this must be the best one around. Thick resilient blade. Comfortable rubberised handle.

TST008

SpeedCatt

STIKATAK



Wide Stair Tool

Gripperrods

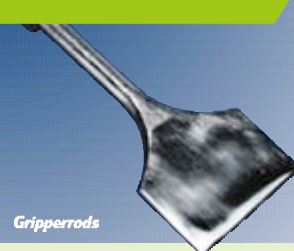

Forged chrome steel stair tool with a 90mm (3 1/2") blade to drive the carpet into the stair crotch.

TST011

The SpeedCatt is a revolutionary tool for the professional floor layer. It has been specifically developed by master fitters who have created the tool with wheels to revolutionise the carpet fitting trade by speeding up the process of creasing and tucking carpets into place saving time and money.

An ideal product for the flooring distributor, the SpeedCatt will complement Stikatak's Trim Master Carpet and Vinyl Trimmer (see pg 36)

N2300 Box of 4

Heat seaming

Heat Seam Iron Grooved

Gripperrods



From the same source as our Super Heat Seam Iron, this is a robust, well designed iron. Features:

- 900W heating element for fast heat up
- Thermostat with five settings
- Three position cable controller allowing trailing cable to be kept out of the way
- Light indicating when iron is up to temperature
- Sturdy steel tray

THS001

Super Heat Seam Iron

Gripperrods



An exceptional seaming iron with many features that make it ideal for seaming all carpet types, including felt backs. 900W heating element for fast heat up. Tough, non-stick coating on ribbed base. Patented Teflon Carpet Guard system prevents distortion of sensitive backings. Cut away at the front of the iron to ensure backing is pre-heated. Two light safety indicator; red light 'caution, power on, iron is hot'. Green indicator lights up when selected temperature is reached. Easily adjusted, top mounted dial for setting temperature with table showing setting and temperature. Three position cable controller allowing trailing cable to be kept out of the way. Super cool handle and sturdy steel tray.

Heat Seaming Tape (item 6702B) is designed specifically for use with this iron when seaming felt backs. Seams and seals in one operation. See Page 31.

THS002

Seam Weight

Gripperrods

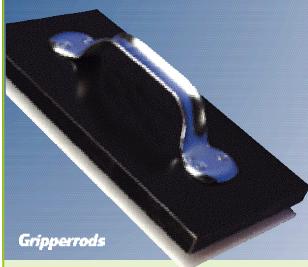

A specially designed tool to apply even, downward pressure across the seam as it cools. Installers often use their tool box for this purpose; this doesn't do the job properly but does indicate the need for a tool!

- Heavy cast iron top plate (17lb/7.7kg) ensures uniform pressure over whole area (6" x 12"/15 cm x 30 cm)
- Flat, durable Teflon base with perforations to allow proper cooling by allowing heat and moisture to escape through the carpet surface
- Top handle combined with Teflon base allows easy movement with no discolouration

An essential tool for professional installers seeking to make consistently high quality seams.

THS005

Grooming Roller

STIKATAK



Helps produce a better seam when using Heatac tapes. When used behind the iron, angled roller wheels tend to pull the nap of the carpet together, achieving better penetration between carpet backing and hot thermoplastic adhesive. For sensitive piles, use THS004 smooth roller.

NR93915

Silvaseam® Seaming System

Gripperrods

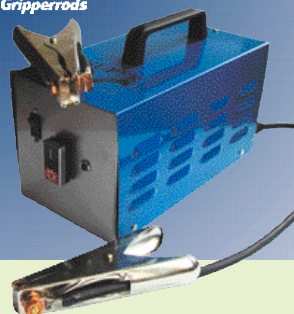

Enables the fitter to quickly and efficiently create an extremely strong seam on conventionally woven carpets. Suitable for contract and domestic use. Ideal for contract seaming.

THS007

Probe & Plate Pack

Set of two additional probes and plates allowing longer seams (greater than 10m) to be created quickly and efficiently.

THS007P

Silvaseam Tape

For use with the THS007 machine. See Page 31.

2000

Seam Roller Smooth

Gripperrods

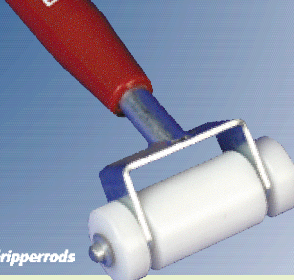

For seaming carpets with sensitive pile which might burst using a starwheel roller. Smooth roller enhances a good finished seam without leaving wheel marks in the pile.

THS004

Invisiseamer

Gripperrods



The definitive tool for cutting carpets prior to seaming. Invaluable for borderwork. Supplied with a 73cm (2'5") base. Longer bases available.

TMM013

**1.83m (6')
base only
3.66m (12')
base only**

TMM015

TMM016

TOP TIP

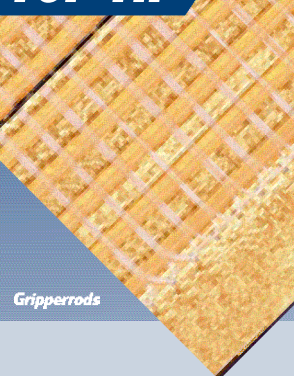

Gripperrods

Choose our top seaming tape for high traffic areas

Ideal for any carpet seam in even the heaviest traffic conditions, Gripperrods Gold Line Heat Seaming Tape is the top of our heat seam tape range.

- Supreme quality adhesive with high density glass fibre yarn combine to give the strongest possible seam
- Gold foil enables close control of the seaming process (temperature and speed) for more difficult carpets

For details of this and our full range of Heat Seaming Tapes see Pages 30 & 31.

Knee pads

STIKATAK



Extremely comfortable and sturdy knee pads eliminate problems often experienced from constant kneeling on cold, hard surfaces. Single pair.

NR91665

Carpet Carrier

Gripperrods



Sturdy, tubular steel frame, large pneumatic tyres and smooth roller bearings absorb heavy loads in the warehouse or showroom. Maximum safe working load 400 kilos.

THP001

Gripperrods Tool Kit



A complete carpet fitting tool kit, including all the tools required for a professional carpet fitter.

This comprehensive kit is supplied in a handy Gripperrods toolbag as featured above.

N1

Kit includes:

- NJ42** Conventional Knee Kicker
- TST011** Wide Stair Tool
- NJ51** Hammer Tacker
- NJ54** Hammer Tacker
8mm Staples
- TCT001** Dolphin Knife
- TSP010** Tack and Moulding Lifter
- NR93310** Chalk Line and Reel
- TCT018** Gripper Shears
- NJ23A** 7.5m Tape Measure
- NJ50** Tool bag

Wood/laminate underlays

Plastifoam White Underlay

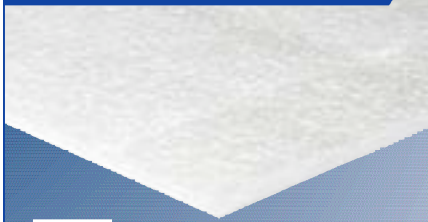

STIKATAK

A light polyethylene underlay suitable for use under wood or laminate floors.

Size: 10 m x 1 m
Coverage: 10 sq mtr
Thickness: 1.8 mm

- 1.8mm Polyethylene
- Noise reduction of 18 dB
- Easy to fit

EW210 Pack of 8

Paper Felt and Interlay

Paper felt and interlay prevent foam backed carpets and underlays from adhering to the sub floor, increase insulation and prevent dust from rising through floorboards.

Available in a range of weights and roll sizes to suit all needs.

6950	Paper felt - Light, 100m x 1 m
PF1	Paper felt - Medium, 100m x 1 m
PF2	Paper felt - Medium, 100m x 2m
6959	Paper felt - Heavy, 50m x 2m
TIN1	Interlay, 200m x 1.5m

Timbermate Duratex



Duralay

The traditional high density rubber underlay for use under laminate, solid timber and engineered wooden floors.

Size: 11 m x 1.37m
Coverage: 15.07sq mtr
Thickness: 3.60 mm

- Drum sound emission of 57 Sone
- Drum Sound classification SL30
- Noise reduction of 24 dB

DTX11013

Silverlay Underlay

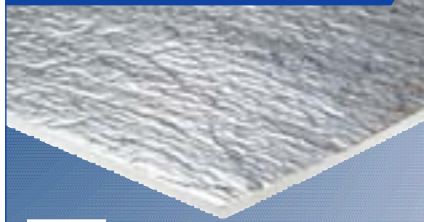

STIKATAK

2 mm polyethylene foam underlay with built-in silver foil moisture barrier and self adhesive overlap. Silverlay wood & laminate underlay is composed of a polyethylene foam, which is laminated with an integral overlapping silver metalised polypropylene film damp proof membrane of 20 micron.

Size: 10 m x 1 m
Coverage: 10 sq mtr
Thickness: 2 mm

- 2 mm Polyethylene
- Noise reduction of 18 dB
- Excellent thermal and shock insulation qualities
- 10cm overlapping moisture barrier membrane
- Integral self-adhesive fixing tape
- Odourless & non staining

EW410 Pack of 8

Timbermate Excel



Duralay

Timbermate Excel is the UK's premier underlay for wood and laminate floors.

With a built in Vapourstop barrier, Timbermate Excel will protect against moisture; eliminating the need for polythene sheeting, when used in conjunction with Vapour Tape or Vapourstop sealing strip.

Size: 11 m x 1.37m
Coverage: 15.07sq mtr
Thickness: 3.60 mm

- Drum sound emission of 56 Sone
- Drum Sound classification SL30
- Noise reduction of 23 dB

TEX11013

All In One Blue Underlay

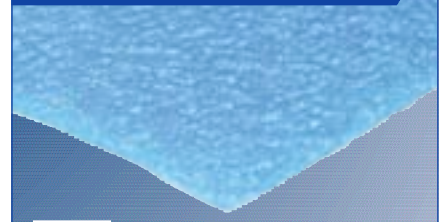

STIKATAK

All in one underlay is composed of a light 3mm polyethylene with an integral damp proof membrane whose thermal and sound insulation qualities are ideal for wood and laminate floors. Atoxic, odourless and chemically inert, all in one does not leave stains and offers an efficient resistance to pressure, repeated shocks and chemicals.

Size: 10 m x 1 m
Coverage: 10 sq mtr
Thickness: 3 mm

- 3 mm Polyethylene
- Noise reduction of 20 dB
- Excellent thermal and shock insulation qualities
- Integral damp proof membrane
- Integral self-adhesive fixing tape
- Odourless & non staining

EW310 Pack of 8

Timbermate Silentfloor Gold



Duralay

Timbermate Silentfloor Gold is the ultimate solution to noisy wood or laminate flooring.

Silentfloor Gold offers the highest specification acoustic performance, highest density rubber underlay, with a built in Vapourstop barrier.

Silentfloor Gold will protect against moisture, eliminating the need for polythene sheeting when used with Vapour Tape or Vapourstop sealing strip.

Size: 11 m x 1.37m
Coverage: 15.07sq mtr
Thickness: 4.20 mm

- Drum sound emission of 53 Sone
- Drum Sound classification SL30
- Noise reduction of 24 dB

SILGOLD

Contents

Metal Edgings

Page 44

Clip System

Page 46

Carpet Gripper

Page 47

Flooring Adhesives

Page 47

Sealants & Screeds

Page 48

Double Sided Tapes

Page 48

Single Sided Tapes

Page 49

Floor Pro Tools

Page 49

Floor Cleaning Products

Page 50

Floor Care Products

Page 51

Wrapping & Packing

Page 52

Merchandising Stands

Page 52

A range of retail packaged flooring accessories, designed to help the retailer when presenting in store.



Retail packaged metal edgings

Vinyl & carpet edges

Finish

0.90m x 10
Per Tube1.80m x 10
Per Tube

Vinyl Edge Small - 27mm wide



For resilient floor coverings up to 4mm thick. Has a high lustre finish in both gold anodised and polished aluminium. Includes fixings.

Aluminium
Gold

M07P3A-E
M07P3G-E

M07P6A
M07P6G

Vinyl Coverstrip - 25mm wide

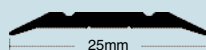

Conceals and protects joints between all grades and thicknesses of resilient floor coverings. High lustre finish in both gold anodised and polished aluminium. Includes fixings.

Aluminium
Gold

M01P3A-E
M01P3G-E

M01P6A
M01P6G

Carpet Coverstrip - 36mm wide

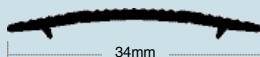

The angled ribs extruded on the underside lock into the carpet pile and draw the two edges together when the strip is screwed to the floor. Suitable for use with all types of carpet. High lustre finish in both gold anodised and polished aluminium. Includes fixings.

Aluminium
Gold

M19P3A-E
M19P3G-E

M19P6A
M19P6G

Contract Coverstrip - 36mm wide



Designed for use with low pile carpets, carpet tiles or resilient floor coverings. High lustre finish in both gold anodised and polished aluminium. Includes fixings.

Aluminium
Gold

M11P3A-E
M11P3G-E

-
-

Coverstrip Extra Wide - 60mm wide

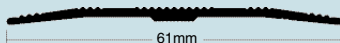

The widest Coverstrip in the range to cover difficult joints between any floor coverings. Includes fixings.

Aluminium
Gold

M12P3A-E
M12P3G-E

M12P6A
M12P6G

Carpet Edge

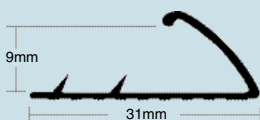

High lustre finishes in both gold anodised and polished aluminium.

Aluminium
Gold

M29P3A-E
M29P3G-E

M29P6A
M29P6G

Dualgrip™

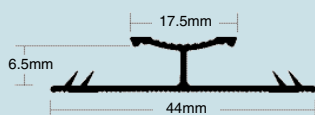

Designed to give a neat joint across the doorway in stretch carpet to carpet installations.

Aluminium
Gold

M39P3A-E
M39P3G-E

M39P6A
M39P6G

Zig Zag™ - 9mm

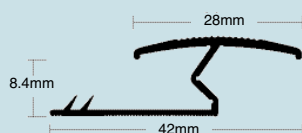

Gives a neat transition between laminate / smooth flooring and adjacent stretch carpet installation. Top of section should be lightly dressed down using a rubber mallet after fitting, to ensure a snug fit to edges of both floor coverings.

Aluminium
Gold

M34P3A-E
M34P3G-E

M34P6A
M34P6G

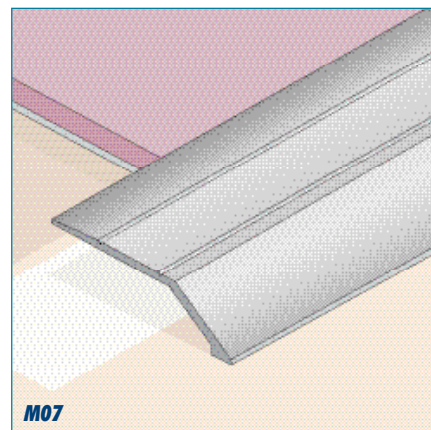

M07

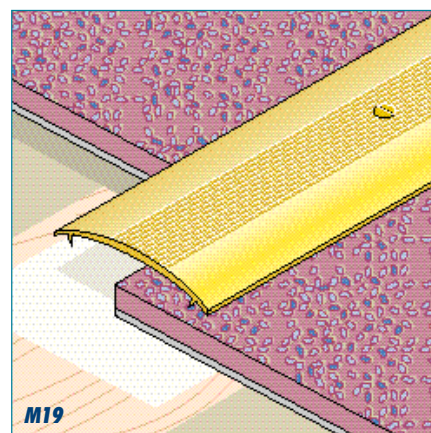

M19

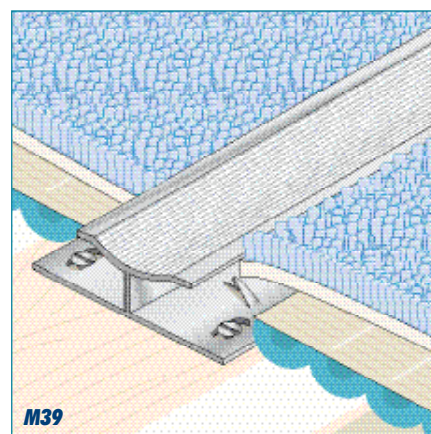

M39

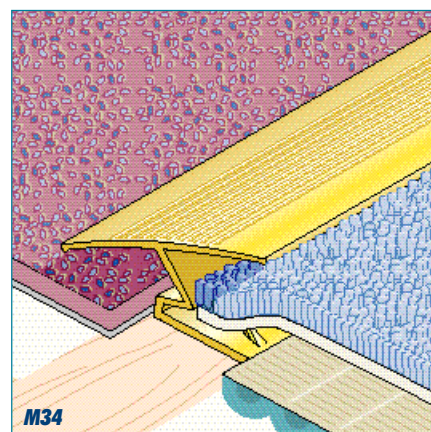

M34

Wood & laminate edgings

Finish

0.90m x 10
Per Pack

STIKATAK

Angle Edge - 8mm - Self adhesive



Gives a smooth transition down to resilient floorings. Drilled, countersunk and supplied with screws. Available in high lustre gold anodised finish. Includes fixings.

Matt Silver
Matt Gold
Beech
Oak

M04P3AMA
M04P3GMA
M04P3WBA
M04P3WOA

Euro Coverstrips - 40mm - Self adhesive

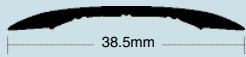

High quality coverstrip for use with most flooring types of equal levels. Includes fixings.

Matt Silver
Matt Gold
Beech
Oak

M13P3AMA
M13P3GMA
M13P3WBA
M13P3WOA

Zig Zag™ - 9mm

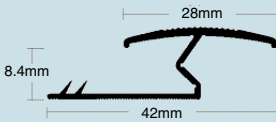

Gives a smooth transition between laminate and an adjacent stretch carpet installation. Top of section should be lightly dressed down using a rubber mallet after fitting, to ensure a snug fit to edges of both floor coverings.

Aluminium
Gold
Matt Silver
Matt Gold
Beech
Oak

M34P3A-E
M34P3G-E
M34P3AM
M34P3GM
M34P3WB
M34P3WO

Nosings - Self adhesive - 9mm

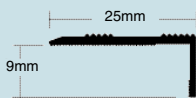

Ideal for use on wood / laminate flooring where a self adhesive fixing is required.

Matt Silver
Matt Gold
Beech
Oak

M74P3AMA
M74P3GMA
M74P3WBA
M74P3WOA

Roundedge™ - 8.5mm

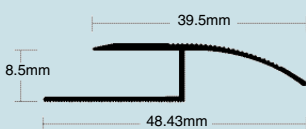

Gives a smooth transition down to adjacent resilient flooring. Fits over edge of laminate. Allows for expansion. No screws or fixings required.

Matt Silver
Matt Gold
Beech
Oak

M83P3AM
M83P3GM
M83P3WB
M83P3WO

Doubledge™ - 8.5mm

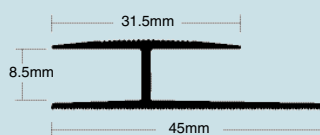

Gives a pleasing finish covering the joint between two areas of laminate. Fits over two adjacent laminate edges allowing for expansion. No screws or fixings required.

Matt Silver
Matt Gold
Beech
Oak

M84P3AM
M84P3GM
M84P3WB
M84P3WO

Squareedge™ - 8.5mm

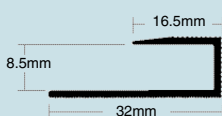

To give a neat square edge against which to butt other floor coverings. Also effective for finishing around French windows or raised thresholds. Fits over edge of laminate. No screws or fixings required.

Matt Silver
Matt Gold
Beech
Oak

M85P3AM
M85P3GM
M85P3WB
M85P3WO

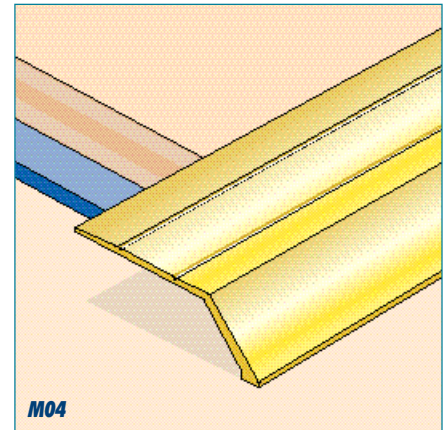

M04

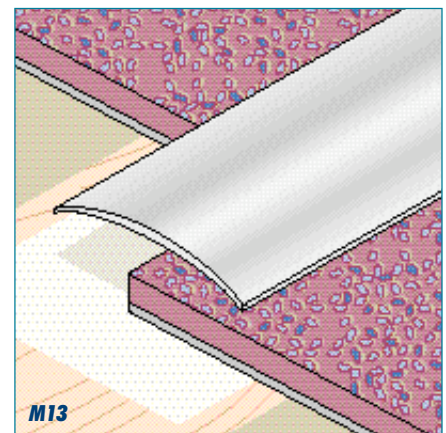

M13

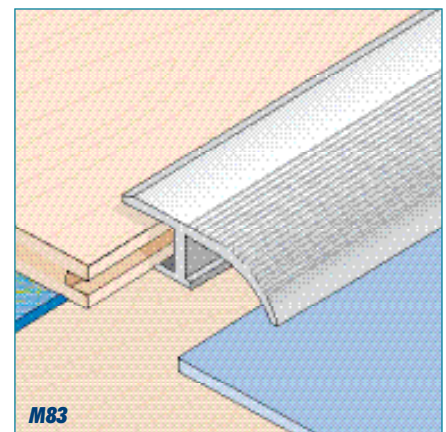

M83

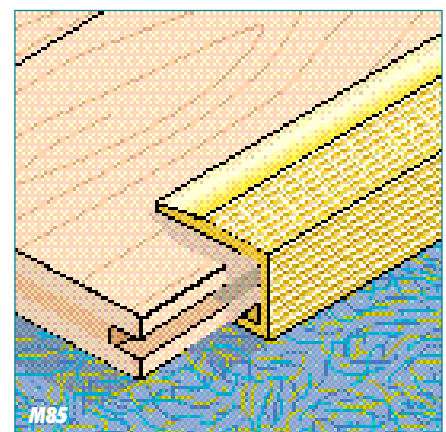

M85

Retail packaged clip system



Floor Pro Clip System

Ideal for fitting laminate, wood and ceramics, vinyl or, indeed, any type of floor covering up to 22mm. It's never been easier to fit the Floor Pro Clip System, now with one self adhesive base, no screws needed and only two tops to choose from. It's never been simpler!

Available Colours

Matt Gold	Matt Silver	Light	Medium	Cherry	Dark	Rustic Oak	Red Wood

Coverstrip

For joining similar level flooring

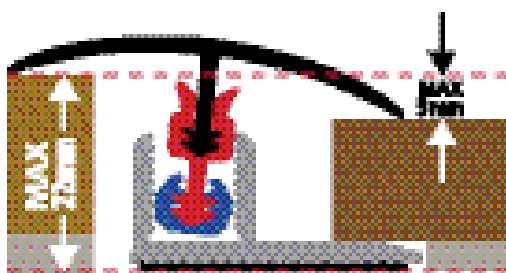

figure 1

Transition Strip

For joining different level flooring

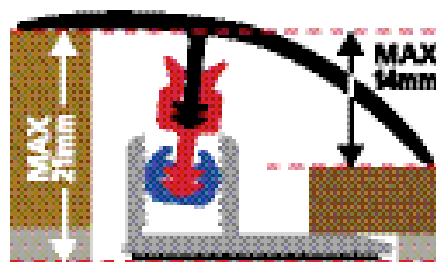
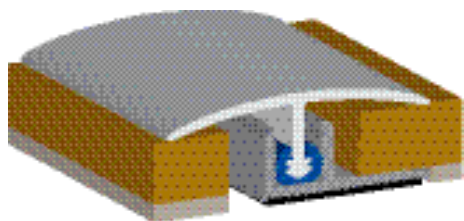

figure 2

Coverstrip & Base

- **Flooring of the same level**
up to a maximum height of 18mm
- **For heights up to 13mm**
the blue clip alone is used
- **For heights between 14mm and 18mm**
the blue and red clips are used together



- **Flooring of different levels**
up to a maximum height of 22mm and a maximum height difference of 9mm
- **For heights up to 17mm**
the blue clip alone is used
- **For heights between 17mm and 22mm**
the blue and red clips are used together, see figure 1

Transition Strip & Base

- **Flooring of different levels**
the transition strip is used for heights up to a maximum of 21mm and a height difference of 14mm
- **For heights up to 15mm**
the blue clip alone is used
- **For heights between 15mm and 21mm**
the blue and red clips are used together

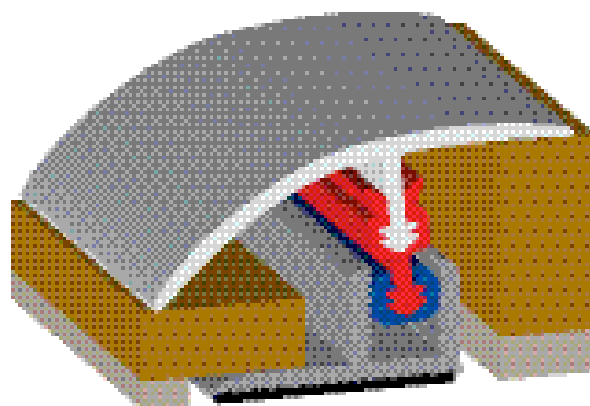

Finish	0.90m x 10 Per Pack	1.80m x 10 Per Pack	2.70m x 5 Per Pack
Matt Silver	M51P3AM-E	M51P6AM	M51P9AM
Matt Gold	M51P3GM-E	M51P6GM	M51P9GM
Light	M51P3WAS-E	-	-
Medium	M51P3WB-E	-	M51P9WB
Cherry	M51P3WC-E	-	M51P9WC
Dark	M51P3WO-E	-	M51P9WO
Red Wood	M51P3WR-E	-	-
Rustic Wood	M51P3WRU-E	-	-

Finish	0.90m x 10 Per Pack	1.80m x 10 Per Pack	2.70m x 5 Per Pack
Matt Silver	M52P3AM-E	M52P6AM	M52P9AM
Matt Gold	M52P3GM-E	M52P6GM	M52P9GM
Light	M52P3WAS-E	-	-
Medium	M52P3WB-E	-	M52P9WB
Cherry	M52P3WC-E	-	M52P9WC
Dark	M52P3WO-E	-	M52P9WO
Red Wood	M52P3WR-E	-	-
Rustic Wood	M52P3WRU-E	-	-

Retail packaged carpet gripper

Gripperrods

Dual Purpose - Medium Pin - Carpet Gripper

4.8mm (3/16") The more usual pin length, suitable for most types of carpets.

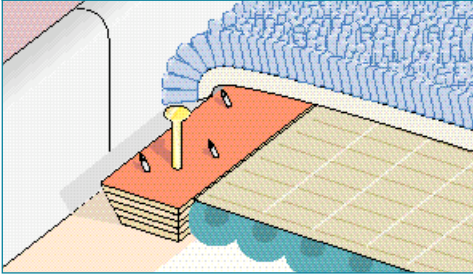

Medium pin carpet gripper, display packed for retail display. Supplied pre nailed with dual purpose nails for use on most wood and concrete floors.

G5D-8/12 12 x (8 x 1.52m Lengths)
146m (480') Per Carton

Retail packaged flooring adhesive



Flooring Adhesive

Water Based Wood Flooring Adhesive



Wood flooring adhesive is a high performance, high solids, water based acrylic adhesive designed for the interior bonding of solid wood plank. The maximum plank size is 1200mm x 120mm.

Item	Per Pack	Contents	Wood Plank Coverage
ST1205	4	5kg	5m ²
ST1215	1	15kg	15m ²

Vinyl, Carpet & Cork Adhesive



A solvent free, low V.O.C., acrylic based adhesive with excellent bond strength. Suitable for use with carpet backings and both plasticised and non-plasticised vinyls.

ST701	6 x 1kg	Approx. 3m ² coverage
ST702	4 x 2.5kg	Approx. 7m ² coverage
ST705	4 x 5kg	Approx. 15m ² coverage

Wood Flooring Tongue & Groove Adhesive



A solvent free, specialist PVA dispersion water resistant to D3 for wood and laminate flooring, plastic laminates and general woodworking applications.

ST773	500ml x 12 per pack	Approx. 10-15 linear m per 500ml
--------------	---------------------	----------------------------------

Scotia & Skirting Fixing Adhesive



A high strength, gap filling water based adhesive mastic for the fixing of scotias, quadrants and skirtings to wood, chipboard, brick, plaster and stone. Can also be used to fix dado rails and skirting boards

S106	310ml x 12 per pack	Approx. 12 linear m per 310ml
-------------	---------------------	-------------------------------

Retail packaged sealants & screeds

Flooring gap sealant

Wood & Laminate Flooring Gap Sealant



Flexible, water resistant sealant and gap filler in four colours for sealing around wood and laminate flooring. It has a silk finish and is resistant to mould and household cleaners.

Item	Per Pack	Contents	Colour	Approx. Coverage
S101	12	125ml	Clear	5 linear m
S102	12	125ml	Light	5 linear m
S103	12	125ml	Medium	5 linear m
S104	12	125ml	Dark	5 linear m

Laminate Joint Moisture Guard



Flexible, water resistant joint sealer for glueless laminate floors. For use in moisture prone areas such as kitchens, bathrooms and utility areas.

S105 125ml x 12 per pack
Approx. 10 linear m per 125ml

Level A Floor



Level A Floor is a two part self levelling, fast setting screed used to prepare, repair & level sub-floors that are structurally sound (not breaking up or crumbling), for the installation of new floor coverings or application of flooring adhesives.

SEL10 1 x 10kg
Approx. 1.5m² at 3mm thickness per bucket



Retail packaged double sided tapes

Double sided tapes

Retail Packaged Tapes



Retail packaged adhesive tapes, in 5, 10 and 15 metre rolls

Item	Description	Size	Per Pack
B448/5CB	Vinyl Floor Tape	48mm x 5m	24
B4-48/15CB	Vinyl Floor Tape	48mm x 15m	12
B8-48/10	Carpet Tape - 2 Displays x 16	48mm x 10m	32
B8-48/5	Carpet Tape - 2 Displays x 30	48mm x 5m	60
B848/5CB	Carpet Tape	48mm x 5m	24

Retail packaged single sided tapes

Single sided tapes

Item	Description / Colour	Size	Per Pack
Retail Packaged Tapes			
Retail packaged adhesive tapes, in 4.5, 10 and 15 metre rolls. H9-15 is ideal for the invisible joining of two pieces of carpet.			
C2-48/4.5-0	Waterproof Cloth Tape / Assorted	48mm x 4.5m	30
C2-48/4.5-2	Waterproof Cloth Tape / Black	48mm x 4.5m	30
C248/10-2CB	Underlay Tape	48mm x 10m	12
C5-48/10CB	Laminate Underlay Moisture Proof Joining Tape	48mm x 10m	12
H9-15	Carpet Joining Tape	90mm x 15m	12

Retail packaged Floor Pro tools



Floor Pro Carpet Fitting Kit



The Floor Pro Carpet Fitting Kit has been developed by professionals to allow us all to be flooring professionals too and stretch, re-stretch or re-position carpets the professional way - quickly and effortlessly. The Kit includes:

- Carpet Stretcher, Carpet Tucker** - for tucking carpet behind gripper and on stairs and
- Carpet Knife** - especially designed for ease of use when cutting carpet and underlay.

N2000 4 per pack

Floor Pro Laminate Installation Kit



All you need to install click and glued laminate flooring systems.

- **Tapping Block**
- **20 spacers**
- **Pulling Bar.**

N2005 10 per pack

Floor Pro Carpet Knife



Designed for professionals, cuts carpets and underlay.

N2003 6 per pack

N26 Floor Pro Carpet Knife Blades
10 dispensers of 5 straight blades

Floor Pro Carpet Tucker



All the strength of a conventional stair tool at a fraction of the weight. For tucking carpet behind gripper on stairs.

N2002 6 per pack

Floor Pro Carpet Stretcher



This unique lightweight stretcher allows you to stretch, re-stretch or re-position carpet quickly and effortlessly.

N2001 4 per pack

Floor Pro Vinyl & Carpet Trimmer



Plastic moulded vinyl and carpet trimmer specifically designed for the trimming of thinner floor coverings.

N2004 6 per pack

NR96436 Vinyl & Carpet trimmer Blades
10 dispensers of 5 hooked blades

Retail packaged floor cleaning products

Carpet Stain Remover



Proven instant results on carpets and upholstery in the home, car, workplace. This really works! With the instant foaming action stains are drawn out in seconds and wiped away. no water or rinsing required - just rub with a damp cloth. Pleasant smell, anti-static, easy, safe and effortless to use.

S240 400ml - 12 per pack

Carpet Stain Remover Wipes



Ready to use wipes for carpet and upholstery for everyday stains and spills with Odour Neutraliser and Bactericide. Fast, effective and easy to use.

S242 20 wipes
10 per pack

Vinyl Floor Cleaner



Floor Pro Vinyl Floor Cleaner is a quick and easy to use 'spray and go' cleaner for the removal of dust and dirt from vinyl and linoleum. No need to rinse and dry. Daily use will keep the floor clean and prevent dirt build up.

S264 500ml - 6 per pack

Vinyl Floor Polish



Floor Pro Vinyl Floor Polish is a ready to use high gloss, slip resistant protective formulation that enhances the appearance of both vinyl and linoleum flooring. Polish is the essential protection for newly laid or unpolished floors and for floors where the old polish has been removed.

Suitable for use on Vinyl, Linoleum, Sealed Cork and Sealed Wood (except for oiled wood floors).

S267 500ml - 6 per pack

Laminate Floor Wipes



- One side removes marks.
- One side gently cleans.
- Moistened with special cleaning liquid.

S300 25 Wipes - 6 per pack

Laminate Clean & Shine



- No build up of polish.
- Dries to a sparkling shine.
- Enhances wood grain look.
- Cleans your laminate floor safely.
- Polymer film protects laminate from wear.

S244 500ml - 6 per pack

Laminate Floor Cleaner



A quick and easy to use, extremely effective cleaner for laminate floors. Dirt and dust are easily picked up, rubber heel marks and sticky spills removed, leaving no dulling residue. After cleaning no drying time is required and daily use will keep floors clean and prevent dirt building up.

S249 1ltr - 6 per pack

Wood Floor Cleaner



Floor Pro wood floor cleaner is a sprayable cleaner specifically formulated for use on solid wooden floors. Regular use will keep floors free from dust and dirt.

S251 500ml - 6 per pack

Wood Floor Polish



Floor Pro wood polish is a ready to use polymer dispersion providing a high gloss protective finish for all types of wood flooring. The dry film provides slip resistant protection for both sealed and unsealed wood flooring (except for oiled wood floors).

S252 500ml - 6 per pack

Polestar Laminate Floor Electra Dry Wipes



Electrostatic floor wipes for use with the Polestar sweeper.

S294 20 Wipes - 24 per pack

Polestar Laminate Floor Cleaning Kit



Polestar wood / laminate floor cleaning kit can be used with either wet or dry wipes and is designed to reach into edges and corners.

S293 1 per pack
12 per Carton

Retail packaged floor care products



Floor Edge Trims

Finish

2m x 2 Lengths - 10 Per Pack

The Floor Edge

NEW



The new Floor Edge Trim is a patented product which has been designed by Stikatak to bridge the expansion gap between wood / laminate flooring and the skirting. It is self adhesive, easy to fit and sits flat to the floor giving a clean smart finish. Available in 6 colours.

Random Slate	WFT002R
Silver Blue Slate	WFT002S
White Slate	WFT002W
Moroccan Stone	WFT002M
Oak	WFT002O
Light Oak	WFT002LO

Carpet & rug protection

Vinyl Carpet Protector



Quality carpet protector, with studded underside, to protect carpets from soiling and wear in heavy traffic areas.

VCP1 Vinyl Carpet Protector 30m x 69cm - 1 roll per pack (merchandising stand available on pg 52)

VCP6 Vinyl Carpet Protector - Retail pack 1.83m x 69cm - 16 rolls per pack

Rug Anti Kleep



Keeps rugs in their place on smooth floors and carpets. Suitable for use on carpets, ceramics & tiles, wood & laminates and vinyl.

URP110 Rug Anti-Kleep Pre-Pack, 110cm x 80cm Pack of 6

URP140 Rug Anti-Kleep Pre-Pack, 140cm x 80cm Pack of 6

URP170 Rug Anti-Kleep Pre-Pack, 170cm x 110cm Pack of 6

UAK92 Rug Anti-Kleep Roll, 25m x 92cm Pack of 1 (merchandising stand available on pg 52)

Paper Felt

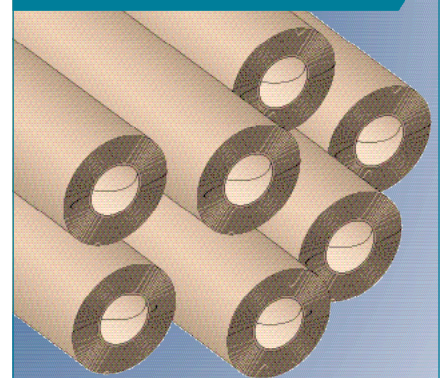

Paper Felt prevents foam backed carpets and underlays from adhering to the sub floor, increase insulation and prevent dust from rising through floorboards.

PS130/20D Paper Felt - Display Pack 1m x 20m - 9 per pack

Tidypipe™



Item

Per Pack

Per Carton

Colours Available

Tidypipe Real Wood

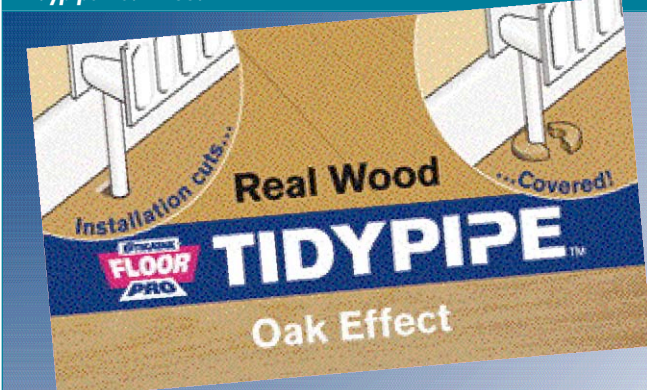

Real wood Tidypipe which covers the exposed gap around 15mm radiator pipes. Also available in a plastic version in silver.

Tidypipe Plastic

WR50O	2	12	Oak
WR50LO	2	12	Light Oak
WR50CO	2	12	Coffee Oak
WR50WO	2	12	Wheat Oak
WR50B	2	12	Beech
WR50AS	2	12	Maple
WR50W	2	12	White
WRP50S	2	12	Silver

Floor care products cont...

Wooden Doorstop



Real Wood rubber bumper to prevent damage to walls and skirtings.

S284 12 packs of 1 per carton

Castor Cups - Clear



Protects carpet, underlay and hard flooring from damage caused by furniture.

S280 Transparent 45 mm diameter
12 packs of 4 per carton

S281 Transparent 60 mm diameter
12 packs of 4 per carton

Felt Pads



Protects hard flooring from damage caused by furniture.

S282 Felt Pads Round
16 x 19mm & 12 x 38mm
28 packs of 12 per carton

S283 Felt Pads Rectangular
160 mm x 120 mm
2 packs of 12 per carton

STIKATAK

Wrapping & packing

Handywrap - 17 micron



Dispensable protective wrapping

T440 Refill Pack (with free handle)
17 micron
150m x 100mm
10 rolls Per Pack

Layflat Polythene Tubing - 250 Gauge

Provides protection for rolls of carpet and vinyl.

TL20 Layflat Polytube - 250 Gauge
302m x 508mm
1 Roll Per Pack

TL26 Layflat Polytube - 250 Gauge
232m x 660mm
1 Roll Per Pack

Merchandising stands

STIKATAK

Rug Anti-Kreep Stand



Double sided Rug Anti-Kreep to prevent the movement of rugs on both soft and hard flooring.

Y3 Rug Anti-Kreep Stand
Height 1750mm x Width 640mm x
Depth 640mm

Floor Fitting Accessories & Floorcare Stand



Ideal way to display flooring accessories in a retail environment.

Y8 Floor Fitting Accessories & Floorcare Stand
Height 2050mm x Width 1030mm x
Depth 500mm

Y8 Extension Unit for longer lengths of edgings

Y9 Height: 1880mm x Width: 520mm x
Depth: 460mm

Carpet Protector Stand

Y1 Height: 1320mm x Width: 815mm x
Depth: 110mm

▼ A	Page No	FLOOR CARE	50-52	▼ N	Page No	STK 950 ADHESIVE	24
ADHESIVE & SCREED APPLICATION	35	FLOOR CLEANING	50	NAILS & SCREWS	37	STK 1000 DPM	27
ADHESIVE APPLICATOR BOTTLE	35	FLOOR EDGINGS	5-14	NAPLOCK	17	STK 1100 PRIMER	26
ADHESIVE CARTRIDGE GUN	35	FLOOR PRO CARPET FITTING KIT	49	NEAT EDGE GRIPPER	3	STK 1200 SMOOTHING COMPOUND	26
ADHESIVE SELECTOR CHART	28	FLOOR PRO CARPET KNIFE	49	▼ O	Page No	STK 1300 SMOOTHING COMPOUND	26
ADHESIVE TROWEL - B1 NOTCH	35	FLOOR PRO CARPET STRETCHER	49	OWN PRINT GRIPPER	3	STK 1350 LATEX LIQUID	26
ADHESIVES & SCREEDS	21-29, 47-48	FLOOR PRO CARPET TUCKER	49	▼ P	Page No	STRETCHING, CREASING & TUCKING	39
ALL IN ONE BLUE UNDERLAY	42	FLOOR PRO CLIP SYSTEM	46	PAPER FELT	42	SUPER BLUE - RAPID SET GRIPPER	29
ALUMINIUM EDGINGS	5-14	FLOOR PRO LAMINATE FITTING KIT	49	PAPERFELT - DISPLAY PACK	51	SUPER CARPET SHEARS	36
ALUMINIUM STAIR NOSINGS	9,12,15-17	FLOOR PRO TOOLS	49	PLASTIFOAM WHITE UNDERLAY	42	SUPER CARPET CLAMP	34
ANGLE EDGES	9-10	FLOOR PRO VINYL & CARPET TRIMMER	49	PMR CONTACT ADHESIVE TAPES	33	SUPER HEAT SEAM IRON	40
ARCHITECTURAL GRIPPER	3	FLOORWORKS GRIPPER	4	POLESTAR - ELECTRA DRY WIPES	50	SUPER KNEE KICKER	39
AWL	38	▼ G	Page No	POLESTAR LAMINATE FLOOR CLEANING KIT	50	SUPERSPRAY	29
▼ B	Page No	GENERAL PURPOSE TAPE	32	PRE NAILED GRIPPER	2-4	SUPERSPRAY CONTACT ADHESIVE	29
BLADES	37	GEV - EMICODE	21	PREMIER BRONZE TAPE	32	SWIVEL LOCK POWER STRETCHER	39
BLADES HAND SCRAPER	34	GLIDER	35	PREMIER GOLD TAPE	32	SWIVEL LOCK - CORNER SUPPORT	39
BLIND GRIPPER	3	GLUE CARTRIDGE	35	PREMIER GREEN PMR	32	▼ T	Page No
BULL NOSE	15	GLUE GUN	35	PREMIER SILVER TAPE	32	TACK AND MOULDING LIFTER	34
▼ C	Page No	GLUE STICKS	35	PRE-PACKED GRIPPER	47	TACKFAST GRIPPER	3
CAPPING STRIPS	19	GLUE WIPES	29	PRESSURE SENSITIVE FLOORING ADHESIVE	21	TACKIFIER ADHESIVE	22
CARBIDE BLADE FOR DOOR TRIMMER	36	GOLDEN GRIPPER	2	PROBES 25CM FOR DEEP MEASURES	34	TACKIFIER TROWEL	35
CARPET & VINYL EDGINGS	5-9	GOLDLINE HEAT SEAM TAPE	30	PROFESSIONAL CARPET FITTING KIT	41	TAPE MEASURE	38
CARPET ADHESIVE	22	GRINDING STONE & HANDLE	34	PULLING IRON	38	TAPPING BLOCK	38
CARPET CARRIER	41	GRIPPER	2-4	▼ R	Page No	TEC 3200 HOT MELT GLUE GUN	35
CARPET EDGES	7-8	GRIPPER ADHESIVE	29	RAKED BACK	15	TEC 700 HOT MELT GLUE GUN	35
CARPET GRIPPER	2-4	GRIPPER FOR DOUBLE STICK	4	REGULAR GRIPPER	4	THE FLOOR EDGE	13,51
CARPET PROTECTION	51,52	GRIPPER MITRE SHEARS	37	RETAIL PACKAGED PRODUCTS	43-52	THE LAMINATE FLOOR CLEANER	50
CARPET STAIN REMOVER	50	GRIPPER SHEARS	37	ROLL UP STRAIGHT EDGE	38	TIDYPIPE	51
CARPET STAIN REMOVER WIPES	50	GRIPPERCRETE GRIPPER	2-3	ROLL UP STRAIGHT EDGE & T-SQUARE	38	TIMBERMATE DURATEX	42
CARPET TAPE	32	GROOMING ROLLER	40	ROUNDEDGE	11	TIMBERMATE EXCEL	42
CASTOR CUPS	52	▼ H	Page No	RUG ANTI-KREEP - PRE-PACK	51	TIMBERMATE SILENTFLOOR GOLD	42
CHALK LINE	38	HAMMER TACKER	38	▼ S	Page No	TOOL BAG	41
CHEVRON	15	HAND SCRAPER	34	SCOTIA & SKIRTING FIXING ADHESIVE	47	TRIM MASTER - CARPET & VINYL TRIMMER	36
CLIP SYSTEM	14	HAND TACKER	38	SCOTIA CUTTERS	37	TUCKER	36,39
CONCRETE NAIL GRIPPER	2-4	HANDYWRAP	52	SCREED & PRIMER SELECTOR CHART	27	▼ U	Page No
CONTACT ADHESIVE	23	HEAT SEAM IRON - GROOVED	40	SCREED TROWEL	35	UNDERLAYS FOR WOOD / LAMINATE FLOORS	42
CONTRACT GRIPPER	3	HEAT SEAM TAPE SELECTOR CHART	31	SCREDS - RETAIL PACKAGED	48	UNIVERSAL PRIMER	26
CONTRACT HEAT SEAM TAPE	31	HEAT SEAM TAPES	30-31	SEALANTS - RETAIL PACKAGED	48	▼ V	Page No
COVE FORMERS	19	HEAT SEAMING	40	SEAM WEIGHT	40	VAPOUR TAPE	33
COVER STRIPS	6	HEAVY DUTY CLOTH TAPE	32	SEAMWELL FLAT HEAT SEAM TAPE	30	VAPOURSTOP SEALING STRIP	33
CUSTOM PRINTED GRIPPER	3	HEAVY DUTY STAIR NOSINGS	16-17	SEAMWELL HEAT SEAM TAPE	30	VINYL CARPET & CORK ADHESIVE	47
CUTTING & TRIMMING TOOLS	36-37	▼ I	Page No	SELF ADHESIVE EDGINGS	10-12	VINYL EDGES	6
▼ D	Page No	INTERLAY	42	SET IN SKIRTING	20	VINYL FLOOR CLEANER	50
DIMINISHING STRIP	18	INVISISEAMER	40	SHORT PIN GRIPPER	2-3	VINYL FLOOR POLISH	50
DISPLAY PACKED GRIPPER	47	▼ K	Page No	SILVASEAM MACHINE	40	VINYL PROTECTOR	51
DIVERGENT POINT STAPLES	38	KARPETEDGE	8	SILVASEAM TAPE	31	VINYL PROTECTOR - RETAIL PACK	51
DIY METAL EDGINGS	44-46	KNEE PADS	41	SILVERLAY UNDERLAY	42	VINYL SPRAY ADHESIVE	29
DIY PACKED GRIPPER	47	▼ L	Page No	SINGLE EDGES	7-8	VINYL TAPE	32
DIY TOOLS	49	LAMINATE FLOOR CLEAN & SHINE	50	SINGLE SIDED TAPES	33,49	VINYL TO TILE	19
DOLPHIN KNIFE & HOLDER	36	LAMINATE JOINT MOISTURE GUARD	48	SIT ON SKIRTING	20	▼ W	Page No
DOOR TRIMMER KIT	36	LARGE NAPPING SHEARS	36	SLIMLINE STAIR NOSINGS	15-16	WHITE CHALK (225gm BOTTLE)	38
DOUBLE EDGINGS	9,12	LATEX BASED LIQUID	26	SMALL NAPPING SHEARS	36	WIDE STAIR TOOL	39
DOUBLE SIDED ADHESIVE TAPES	32,33,48	LATEX BASED SMOOTHING COMPOUND	26	SMOOTH EDGE GRIPPER	2-3	WOOD & LAMINATE EDGINGS	10-13
DOUBLE STICK CARPET ADHESIVE	24	LATEX SEAMING ADHESIVE	23	SMOOTH SEAM ROLLER	40	WOOD & LAMINATE FLOORING GAP SEALANT	48
DOUBLE STICK FLOOR PREPARATION	25	LAYFLAT TUBING	52	SMOOTHING COMPOUND	26	WOOD ADHESIVE TROWEL	35
DOUBLE STICK INSTALLATION	24,25	LEVEL A FLOOR	48	SOLID BRASS	6,7,9	WOOD EFFECT EDGINGS	10-13
DOUBLE STICK TACKIFIER	24	LIGHTWEIGHT CARPET SHEARS	37	SPEEDCATT	39	WOOD FLOOR CLEANER	50
DUAL PURPOSE GRIPPER	3-4	LINOLEUM KNIFE	36,39	SPRAYS & CARTRIDGE ADHESIVES	29	WOOD FLOOR POLISH	50
DUALGRIP	9	LOK TOP	18	SQUARE NOSE	15	WOOD FLOOR TONGUE & GROOVE ADHESIVE	47
▼ E	Page No	LONG HANDLE FLOOR SCRAPER	34	SQUAREDGE	8,13	WOOD FLOORING ADHESIVE	47
ELECTRIC STAPLER	38	LONG PIN GRIPPER	2-4	STAIR EDGE TRIMS	20	WOOD NAIL GRIPPER	2-4
EPOXY DAMP PROOF MEMBRANE	27	LOOP PILE CUTTER	36	STAIR NOSINGS	9,12,15-20	WOODEN DOORSTOP	52
EURO COVERSTRIP	8,10	LOW EMISSION FLOORING ADHESIVE	21	STAIRRODS	13	WRAPPING & PACKING	52
EXHIBITION TAPE	32	▼ M	Page No	STANDARD GOLD HEAT SEAM TAPE	30	▼ Z	Page No
EXTENDABLE KNEE KICKER	39	MAGNETIC TACK HAMMER	38	STANDARD HEAT SEAM TAPE	31	ZIG-ZAG	8,11,44,45
▼ F	Page No	MEASURING, MARKING & FIXING	38	STAPLES	38		
FAST GRAB MULTIPURPOSE ADHESIVE	22	MERCHANDISING STANDS	52	STICK DOWN GRIPPER (NO NAILS)	3,4		
FELT BACK CARPET FIXING TAPE	33	METAL SNIPS	37	STK 100 ADHESIVE	21		
FELT BACKED GRIPPER	4	MICROPLAST GRIPPER	4	STK 200 ADHESIVE	21		
FELT PADS	52	MICROPLAST STAIR GRIPPER	4	STK 300 ADHESIVE	22		
FITTING TOOLS, BLADES & FIXINGS	34-41,49	MOISTURE INDICATOR	34	STK 400 ADHESIVE	22		
FLEXI EDGE	18	MOISTURE SUPPRESSION	27	STK 500 ADHESIVE	22		
FLEXIBLE PVC NOSING	17	MULTILINE HEAT SEAM TAPE	30	STK 600 ADHESIVE	23		
FLEXIBLE WOOD FLOORING ADHESIVE	23	MUSHROOM TAPE	33	STK 700 ADHESIVE	23		
				STK 800 ADHESIVE	23		
				STK 900 ADHESIVE	24		

Flooring Accessories



Gripperods

The one stop shop for flooring accessories

Treadsafe Distributors Ltd.
Unit 11, Finglas Business Park,
Tolka Valley Road, Dublin 11, Ireland
Tel: +353 1 834 0683
Fax: +353 1 834 0689
Email: sales@treadsafe.ie

www.treadsafe.ie

ts_D
treadsafe
distributors