

OCTOBER 2010



# The Comprehensive CAT

Specialist Floor Trims, Stair Nosings and Stair Rods



[www.treadsafe.ie](http://www.treadsafe.ie)



## *Manufacturers of Specialist Flooring Profiles and Accessories*

*C.A.T. was formed in 1986 with three profiles and an ideal.*

*Today we produce the most select range of flooring edgings to finish the most stylish of floors.*

*Our products are installed worldwide in major commercial projects,  
private buildings and homes.*

*The same ideal remains, though there are now more than three profiles to choose from.*

*Thank you to past and present customers and those specifiers who have  
selected C.A.T. as their chosen supplier.*



C.A.T. a été fondée en 1986 avec un idéal et 3 profils. Aujourd'hui, nous offrons une vaste sélection de revêtement de

plantes afin de donner un fini parfait à vos sols.

Nos produits sont utilisés mondialement que ce soit dans des projets commerciaux, des immeubles ou habitations privées.

Nos idéaux restent inchangés même si nous avons désormais plus de 3 profils différents. Nous remercions nos clients passés et présents ainsi que les entreprises pour avoir choisi C.A.T. comme fournisseur.

### **IMPORTANT NOTICE**

Product Dimensions and Design Changes.

Customers attention is drawn to our company terms and conditions section 7.1

The company reserves the right to alter or change dimensions of goods supplied within reasonable limits having regard to the nature of the goods.

Dimensions specified by the company in this catalogue or on other literature, are to be treated as approximate only unless the customer specifically states in writing that exact measurements are required.

C.A.T. reserve the right to make product design changes to profiles and accessories in this literature for reasons including improvement of performance and other factors dictated by market forces.

### **IMPORTANT QUALITY STATEMENT**

This statement is made in good faith following interest expressed from customers in our products. C.A.T.'s Profiles are regarded as the highest quality available and this is achieved through our monitored manufacturing process that we employ. Our extruded non-ferrous brass and aluminium products are always subject to a faint slubbing effect along the length of the profile and this is inherent in the material due to the extrusion process and is a characteristic of the metal. Since 1986 our principle objective remains "to provide our customers with the very best flooring profiles and accessories available"



C.A.T. entstand 1986 mit drei Profile und ein ideal.

Heute produzieren wir den meisten wählen Sie Bereich des

Bodenbelags Kanten um die elegantesten der Etagen abzuschließen.

Unsere Produkte sind weltweit in großen kommerziellen Projekten, private Gebäude und Wohnungen installiert.

Die gleiche ideale bleibt, obwohl es jetzt mehr als drei Profile zur Auswahl gibt.

Dankeschön Vergangenheit und derzeitigen Kunden und diese Bezeichner, die C.A.T. als Ihre gewählte Lieferant ausgewählt haben.



C.A.T. se formó en 1986 con tres perfiles y un ideal.

Hoy en día producimos la gama más selecta de punta para

terminar la más elegante de pisos de parquet. Nuestros productos están instalados en todo el mundo en grandes proyectos comerciales, edificios privados y casas.

Sigue siendo el mismo ideal, aunque ahora hay más de tres perfiles que puede elegir.

Agradecer al pasado y presentes de los clientes y los especificadores de que han seleccionado C.A.T. como su proveedor elegido.







# Brands



The Akeman Collection

**Akeman Collection™** Stair rods and eyes



**Catwalk™** PVC profiles



**Feline™** Flooring profiles



**Kliks™** Clip in systems



**Kliks Spectrum™** UPVC Clip in systems



**Kliks Spectrum Zip™** UPVC Clip in systems formable



**C.A.T. Olympic™** Exterior Nosings & Accessories



**Reflex™** Expansion profiles



**Tag Trim™** Formable angles



**Timberline™** Profiles for timber floors



**Titan™** Heavy duty profiles



**Tob™** Clip in systems

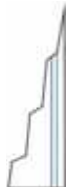

**Vertex™** Corner protection

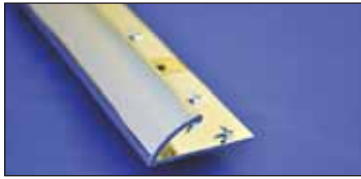

## FLOORING PROFILES

PAGES 10-48

		Page
<b>TWIN PROFILES:</b>	Use with carpet and carpet tiles. T sections for ceramics	11
<b>TWIN TOP SINGLE LEG PROFILES:</b>	For carpet to timber and ceramic floors	12
<b>SINGLE PROFILES:</b>	For carpet and resilient floors	13
<b>SINGLE PROFILES:</b>	For carpet/carpet tile to resilient and ceramic floors	14
<b>COVER PLATES ALUMINIUM:</b>	Use with all types of flooring	15
<b>WIDE ALUMINIUM COVER PLATES:</b>	Available in a variety of width and gauges	16
<b>COVER PLATES BRASS:</b>	Use with all types of flooring	17
<b>COVER PLATES STAINLESS STEEL:</b>	Use with all types of flooring	18
<b>FLAT PLATES:</b>	Available in various widths	19
<b>SMALL FLAT PLATES:</b>	Available in various sizes	19
<b>TRANSITION PLATES:</b>	Wide aluminium transition plates with PVC infills	20
<b>RAMP PROFILES ALUMINIUM:</b>	Use with carpet tiles, barrier mats, ceramics	21
<b>RAMP PROFILES BRASS AND STAINLESS STEEL:</b>	Use with ceramics, timber floors	22
<b>LINO EDGES:</b>	Use with vinyl, linoleum floors	22
<b>ANGLES AND FORMABLE TAG TRIM</b>		23
<b>ALUMINIUM ANGLES:</b>	Straight lengths and formable, various sizes	24
<b>BRASS ANGLES:</b>	Straight lengths and formable, various sizes	25
<b>STAINLESS STEEL ANGLES:</b>	Straight lengths and formable, various sizes	26
<b>CHROME ANGLES:</b>	Straight lengths and formable, various sizes	27
<b>TIMBERLINE PROFILES:</b>	Use with timber and ceramic floors	28
		
<b>CLIP IN SYSTEMS:</b>	Height adjustable for all types of floors	28
<b>KLIKS TWIN PROFILES:</b>	Use with ceramic, timber and laminate floors	30
<b>KLIKS RAMP PROFILES:</b>	Use with ceramic, timber and laminate floors	31
<b>KLIKS LARGE RAMP PROFILES:</b>	Use with ceramic, timber and laminate floors	32
<b>KLIKS END STOP PROFILES:</b>	Use with ceramic, timber and laminate floors	33



	Page
<b>CLIP IN SYSTEMS UPVC</b>	
<b>KLIKS SPECTRUM ZIP:</b>	34
Height adjustable for all types of floors, variety of colours	
<b>KLIKS SPECTRUM INSTALLATIONS</b>	35
<b>KLIKS SPECTRUM ZIP TWIN:</b>	36
Use with carpet, timber and ceramics	
<b>KLIKS SPECTRUM ZIP TWIN:</b>	37
Aluminium base for carpets	
<b>KLIKS SPECTRUM ZIP RAMP:</b>	38
Use with carpet, timber and ceramics	
<b>KLIKS SPECTRUM ZIP RAMP:</b>	39
Aluminium base for carpets	
<b>KLIKS SPECTRUM ZIP END STOP:</b>	40
Use with carpet, timber and ceramics	
<b>KLIKS SPECTRUM ZIP CURVES:</b>	41
For fast forming curves on site	
<b>KLIKS SPECTRUM ZIP CURVES:</b>	42
Curvability information	
 <b>CATWALK CURVABLE PROFILES PVC</b>	 43
<b>CATWALK CURVABLE PROFILES:</b>	44
Twin and Ramp Profiles	
 <b>TOB CLIP IN SYSTEMS ALUMINIUM</b>	
<b>TOB SQUARE EDGE AND TWINS:</b>	45
Use with carpet, timber and ceramics	
<b>TOB RAMPS:</b>	46
Use with carpet, timber and ceramics	
<b>CAPPING AND SKIRTING PROFILES:</b>	47
Capping details and perimeter profiles	
<b>MATWELL FRAMES</b>	48

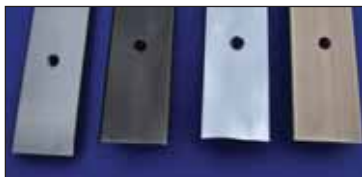

### SPECIAL FINISH FLOORING PROFILES

PAGES 49-53

<b>BRASS PROFILES WITH SPECIAL FINISHES:</b>	49
Choice of finishes available	
<b>BRASS PROFILES WITH SPECIAL FINISHES:</b>	50
Profile selection	
<b>CHROME AND SATIN CHROME ALUMINIUM PROFILES:</b>	51
Choice of finishes available	
<b>CHROME AND SATIN CHROME ALUMINIUM PROFILES:</b>	52
Profile selection	
<b>SPECIAL FINISHES FOR ALUMINIUM AND STAINLESS STEEL:</b>	53
Choice of finishes available	



## FLOOR TRIM FABRICATION

PAGES 54-56

**FLOOR TRIM FABRICATION:**  
**SPECIALISTS IN**  
**FLOOR TRIM FABRICATION:**

Technical information on curved profiles

Page

55

Images

56

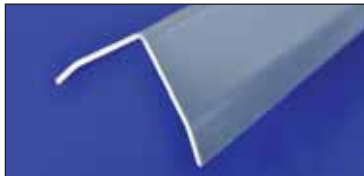

## CORNER PROTECTION PROFILES

PAGE 57

**VERTEX CORNER PROTECTORS:**

Various sizes available



## EXPANSION PROFILES AND MOVEMENT JOINTS

PAGE 58

**REFLEX TECHNICAL INFORMATION**

59



## INSTEP DISCS

PAGE 60

(see also Olympic carbigrp discs page 90)

Various finishes available



## STAIR NOSINGS

PAGES 61-76

**STAIR NOSINGS TECHNICAL INFORMATION:**

Selection and Installation

62

**STAIR NOSINGS TECHNICAL INFORMATION:**

Measuring and Maintenance

63

**STAIR NOSINGS SPECIAL FINISHES**

Choice of finishes available

64

**STAIR NOSINGS TYPICAL APPLICATIONS :**

65

**STAIR NOSINGS INFILLS:**

Choice of infill colours

66

**STAIR NOSINGS BRASS WITH PVC INFILLS:**

5mm gauge

67

**STAIR NOSINGS BRASS WITH PVC INFILLS:**

3.5mm gauge

68



	Page
<b>STAIR NOSINGS BRASS AND ALUMINIUM WITH PVC INFILLS:</b>	3.5mm and 1.5mm gauge
	69
<b>STAIR NOSINGS STAINLESS STEEL WITH PVC INFILL:</b>	8mm gauge
	70
<b>STAIR NOSINGS POLISHES BRASS WITH RIBBED THREADS:</b>	4.6mm gauge
	71
<b>STAIR NOSINGS ALUMINIUM:</b>	Nosings with ribbed threads and PVC infill
	72
<b>STAIR EDGINGS:</b>	Available in aluminium and and stainless steel cover
	72
<b>STAIR NOSINGS ALUMINIUM:</b>	Castellated treads
	73
<b>STAIR NOSING FABRICATION:</b>	Description and template instructions
	74
<b>STAIR NOSING FABRICATION:</b>	Images
	75
<b>STAIR NOSING FABRICATION AND EDGE TRIMS:</b>	Stringer trims and fabrication
	76



## STAIR RODS AND EYES

PAGES 77-85

<b>TIPS FOR MEASURING STAIR RODS</b>		78
<b>SOLID BRASS STAIR RODS AND EYES:</b>	Round rods with turned finials	79
<b>SOLID BRASS STAIR RODS AND EYES:</b>	Round rods with large finials	80
<b>TRIANGULAR BRASS STAIR RODS AND EYES</b>		81
<b>NEW LOOK! OLD EFFECT:</b>	Choice of finishes available	82
<b>HOLLOW BRASS STAIR RODS AND EYES</b>		83
<b>SPECIAL PRODUCTS AND STAIR CLIPS</b>		84
<b>STAIR ROD MAINTENANCE GUIDE</b>		85



## OLYMPIC

PAGES 86-95

### SPECIALIST PRODUCTS FOR INDUSTRIAL AND COMMERCIAL INSTALLATIONS

<b>OLYMPIC HEAVY DUTY STAIR NOSINGS:</b>	Modular Range	88-89
<b>OLYMPIC HEAVY DUTY STAIR NOSINGS:</b>	Feathered edges	90
<b>CARBIGRIP INSERT DISCS AND STRIPS</b>		90



	Page
<b>OLYMPIC HEAVY DUTY STAIR NOSINGS:</b>	
Profile modification	91-92
<b>OLYMPIC HEAVY DUTY STAIR NOSINGS:</b>	
Technical data, maintenance and fixing	93
<b>OLYMPIC TACTILE SYSTEM:</b>	
Indicator, corduroys and studs	94
<b>OLYMPIC INDICATOR CORDUROYS, STUDS AND DISC IMAGES:</b>	95



## FABRICATION AND SPECIAL PRODUCTS

**PAGE 96**

FOR NON STANDARD PRODUCTS OR BESPOKE SERVICES



## SAMPLING AND POINT OF SALES

**PAGE 97**

## PURCHASE ORDER TEMPLATE

**PAGE 98-99-100**

## PRODUCT INDEX

**PAGE 105-106**

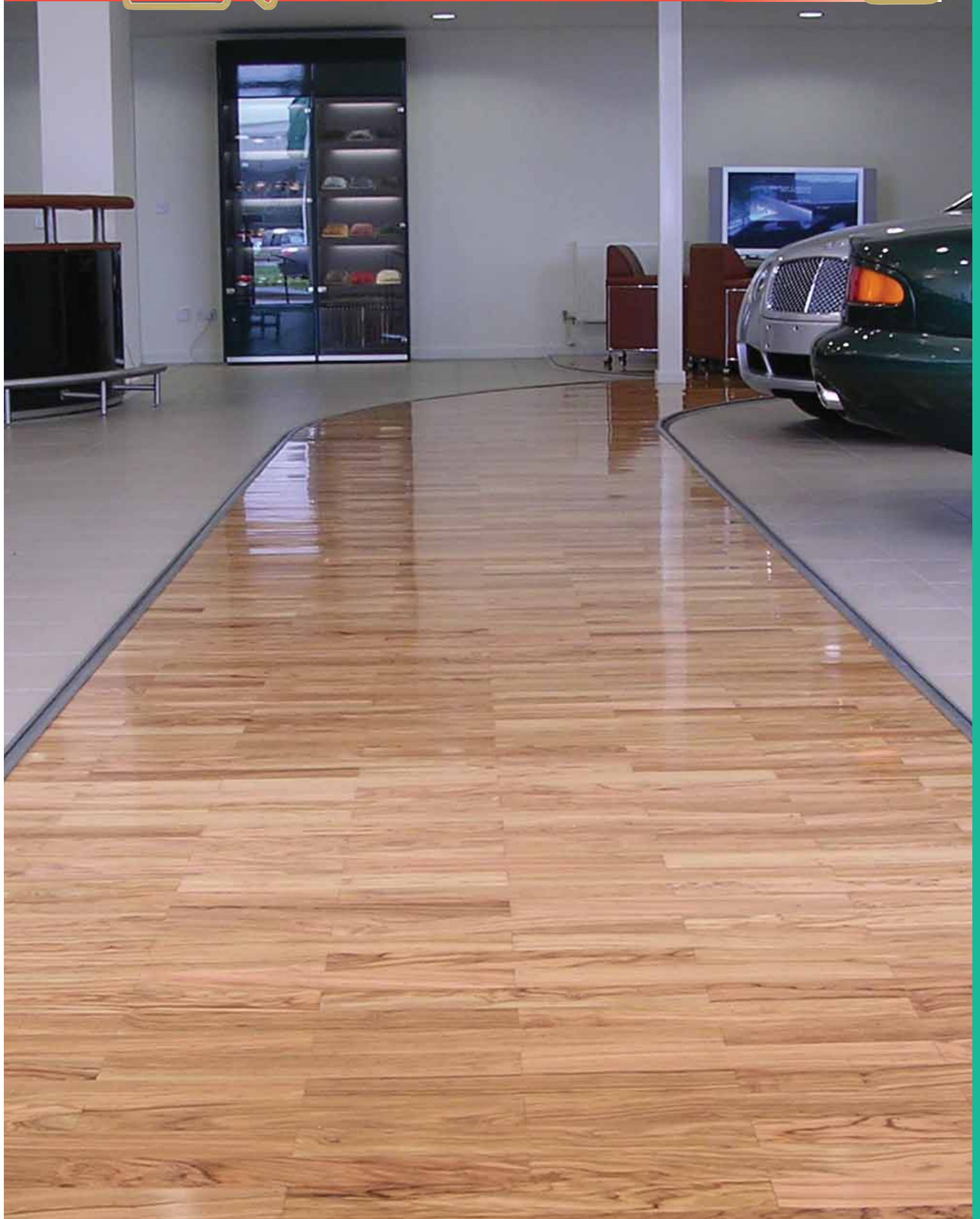

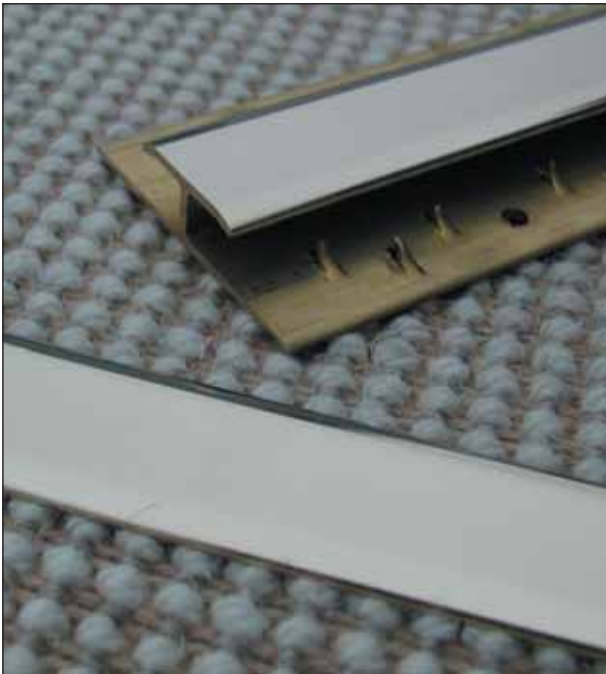
**Feline™ Design © 1993**

Feline profiles have a high quality polished finish and are available with matching single base sections from the C.A.T. feline range.

**Application**

Joining profiles for carpet and carpet tiles.  
T sections for ceramic tiles

**Finishes Available**
**Brass Trims**

- Chrome • Satin Chrome • Nisheen
- Antique Bronze • Antique Brass
- Pearl Chrome and Black Chrome to special order
- Black Chrome max 0.900m length

**Stainless Steel Trims:**

Bright • Brushed

**Aluminium Trims:**

Polished Finish • Satin Finish

**Stock lengths:**

Brass and Aluminium:

2.715m x 6 = Packed 16.29m

0.900m x 6 = Packed 5.40m

Stainless Steel:

2.0m x 6 = Packed 12m

Feline S2 - Patent Pending  
Stainless Steel Cover

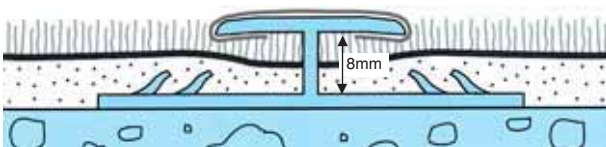

Feline ST - Patent Pending  
Stainless Steel Cover

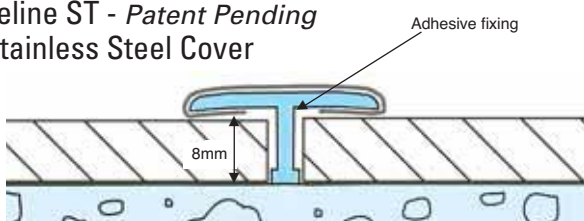

Feline 4  
Brass

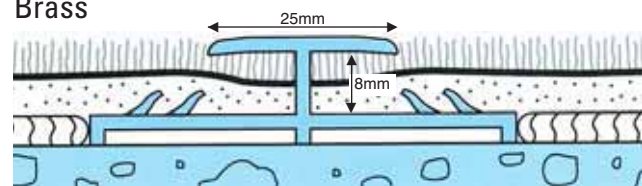

Feline 2  
Brass

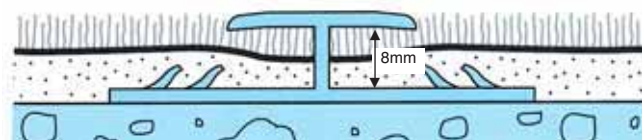

Feline T  
Brass

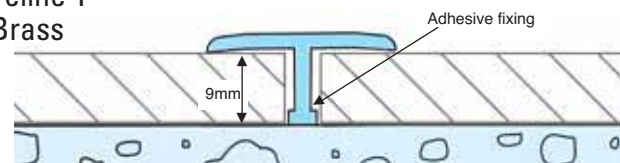

Feline A/9/2  
Aluminium

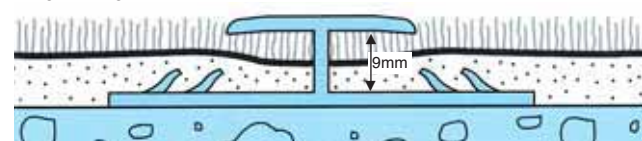

BTG2  
Brass



Illustration shows profile dressed down



## Feline™ Design © 1993

Feline profiles have a high quality polished finish and are available with matching twin base sections from the C.A.T. feline range.

## Application

Feline edgings provide attractive finishing details from carpet to timber and ceramic floorings.

Trim heights can be adjusted with suitable packers

## Finishes Available

### Brass Trims

- Chrome • Satin Chrome • Nisheen
- Antique Bronze • Antique Brass
- Pearl Chrome and Black Chrome to special order
- Black Chrome max 0.900m length

### Stainless Steel Trims:

Bright • Brushed

### Aluminium Trims:

Polished Finish • Satin Finish

### Stock lengths:

Brass and Aluminium:

2.715m x 6 = Packed 16.29m

0.900m x 6 = Packed 5.40m

Stainless Steel:

2.0m x 6 = Packed 12m

Feline S1 - Patent Pending  
Stainless Steel Cover

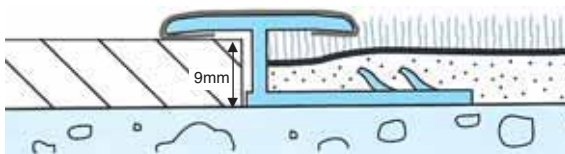

Feline S13 - Patent Pending  
Stainless Steel Cover

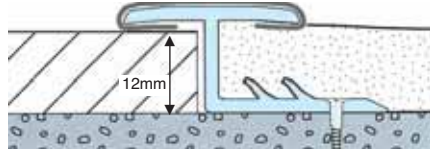

Feline 3  
Brass

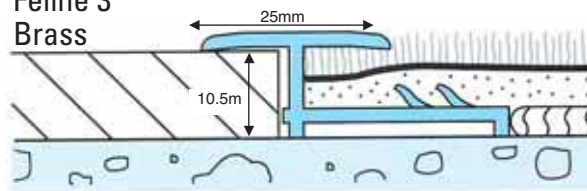

Feline 1  
Brass

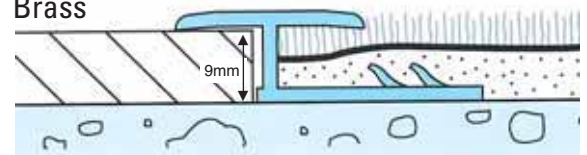

BTG2/SL Brass Only. To special order only  
Brass

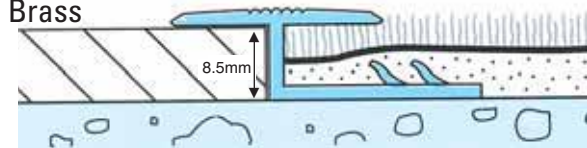

Feline A/10  
Aluminium



Feline A/13 Aluminium

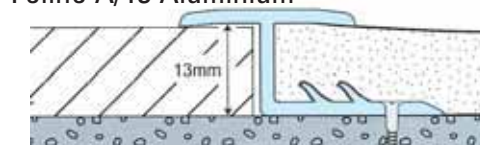

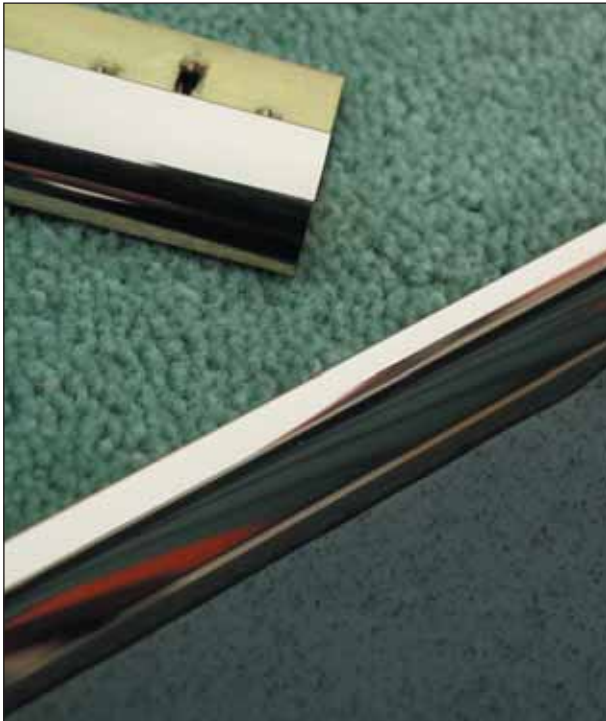

### Finishes available

Refer to the special finishes page for more information

#### Brass Trims

- Chrome ● Satin Chrome ● Nisheen
- Antique Bronze ● Antique Brass
- Pearl Chrome and Black Chrome to special order
- Black Chrome max 0.900m length

#### Stainless Steel Trims:

Bright ● Brushed

#### Aluminium Trims:

Polished Finish ● Satin Finish

#### Stock lengths:

Brass: 2.715m x 6 = Packed 16.29m  
 0.900m x 6 = Packed 5.40m

Stainless Steel: 2m x 6 = Packed 12m

Aluminium: 2.715m x 6 = Packed 16.29m

### Trims for Carpet to resilient floorings

BNR  
Brass

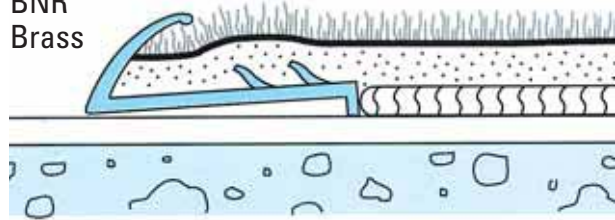

BNF  
Brass

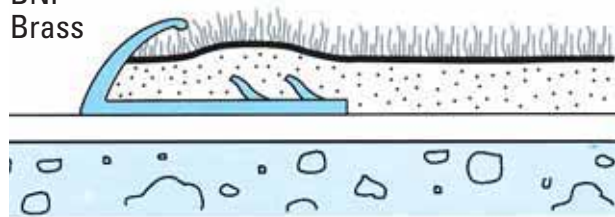

ANF  
Aluminium

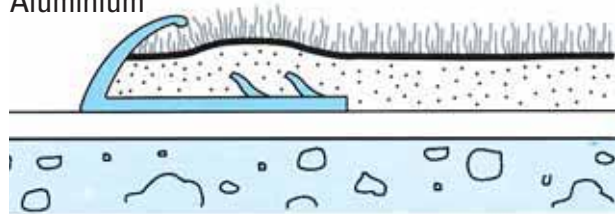

SSNF  
Stainless Steel - supplied without spikes

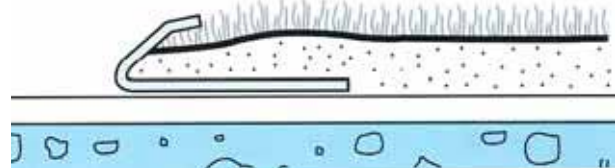

### Trims for Carpet Tiles

Cat 1 Aluminium  
 TT Cat 1 Aluminium-Tag Trim for curving

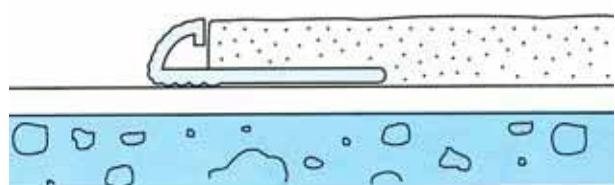



Trims for Carpet/Carpet Tiles to resilient floorings including ceramics.

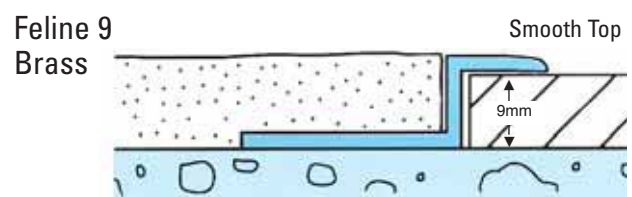
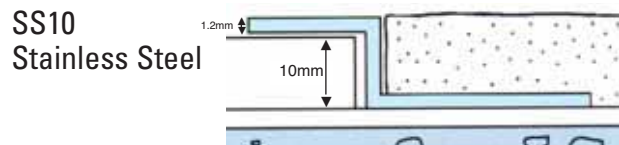
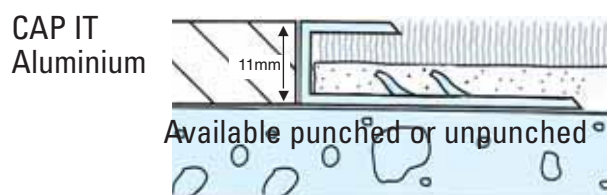
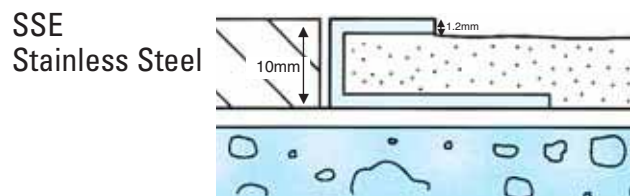
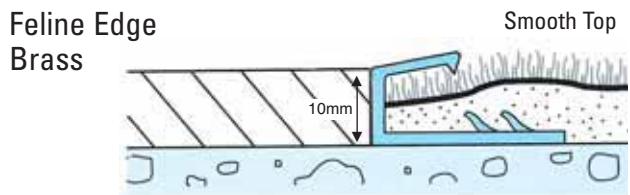
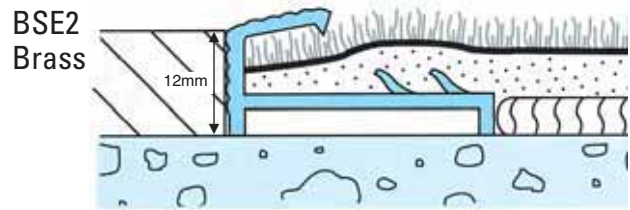

## Finishes available

Refer to the special finishes page for more information

### Brass Trims

- Chrome ● Satin Chrome ● Nisheen
- Antique Bronze ● Antique Brass
- Pearl Chrome and Black Chrome to special order
- Black Chrome max 0.900m length

### Stainless Steel Trims:

Bright ● Brushed

### Aluminium Trims:

Polished Finish ● Satin Finish

### Stock lengths:

Brass: 2.715m x 6 = Packed 16.29m

0.900m x 6 = Packed 5.40m

Stainless Steel: 2m x 6 = Packed 12m

Aluminium: 2.715m x 6 = Packed 16.29m



### Extruded aluminium cover plates

#### Stock lengths:

2.715m x 6 = Packed 16.29m

**Supplied centre drilled** for mechanical fixings. Available undrilled and offset drilled upon request.

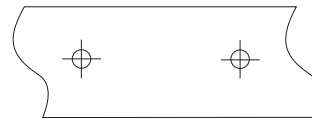

#### Centre Drilled

Stock - Supplied

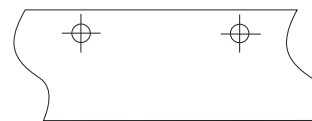

#### Offset Drilled

To special order

#### Finishes available

Refer to the special finishes page for more information

Mill • Mirror • Satin • Silver Anodised

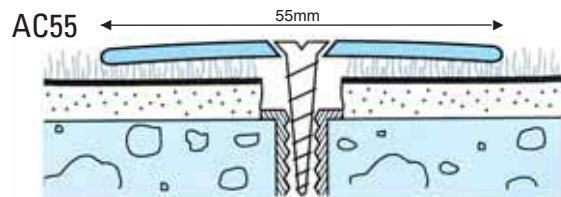
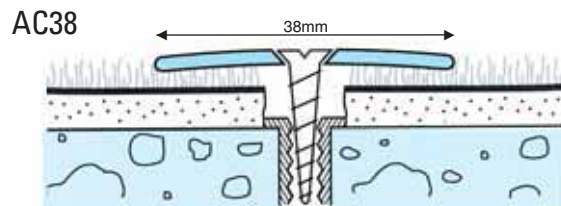

#### Curved Cover Plates



Increasingly popular for installations with floorings with curved lines.

AC38 and AC55 profiles can be curved to template, subject to radius and shape of plate required.

Available in satin finish.

For mirror finish please contact our sales office for suitability.



## WIDE ALUMINIUM COVER PLATES

16

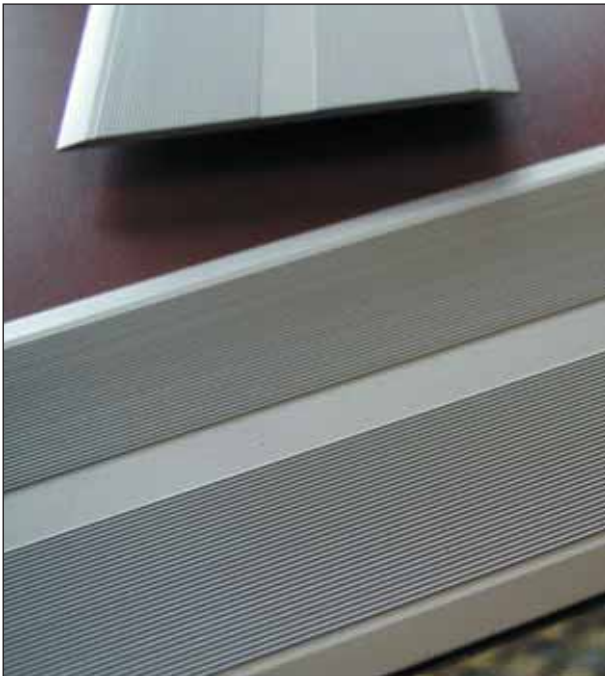

C.A.T. wide cover plates are available in a variety of widths, weights and finishes for all applications.

Supplied centre drilled for mechanical fixings, they are also available offset drilled, staggered drilled or undrilled upon request.

If unspecified centre drilled will be supplied.



**Finishes:** Mill • Satin Aluminium

**Stock lengths:**  
2.715m x 6 = Packed 16.29m

**Centre Drilled**  
Stock - Supplied



To special order

**Offset Drilled**

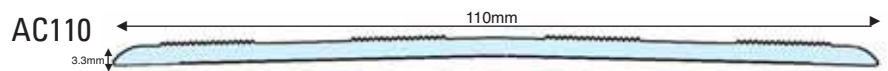
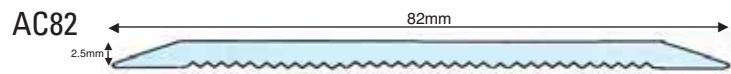

**Stagger Drilled**

**Finish:** Matt Silver Anodised



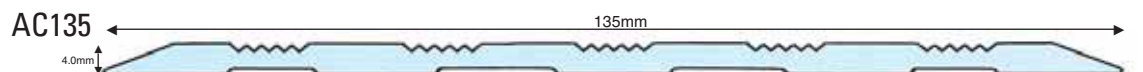
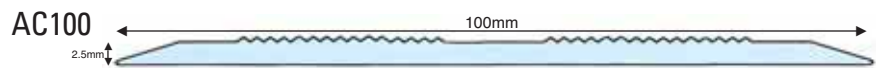
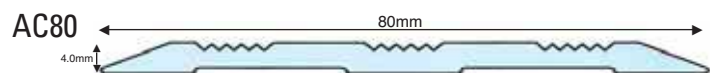

### Special Finishes available BC30 • BC38 • BC55

- Chrome • Satin Chrome • Nisheen
  - Antique Bronze • Antique Brass
  - Pearl Chrome and Black Chrome to special order
  - Black Chrome max 0.900m length
- Special finish cover plates supplied centre drilled.

### Formed brass plates

Not available in Special finishes  
B155 • BEP plates

### Stock lengths:

2.0m x 6 = Packed 12m

B155

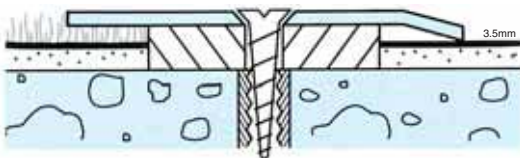

### BEP Applications

Finishing plates for concealing expansion joints

BEP1 : 75mm wide

BEP2 : 100mm wide

**Wider plates** can be made to special order.  
Please specify drilling when ordering.

### Extruded brass cover plates

#### Stock lengths:

2.715m x 6 = Packed 16.29m

0.900m x 6 = Packed 5.40m

**Supplied centre drilled** for mechanical fixings. Available undrilled and offset drilled upon request.

#### BC30 Brass

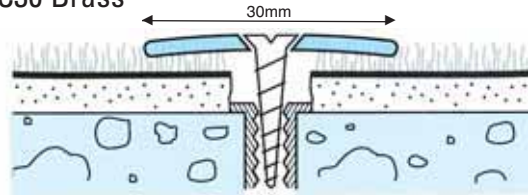

#### BC38 Brass

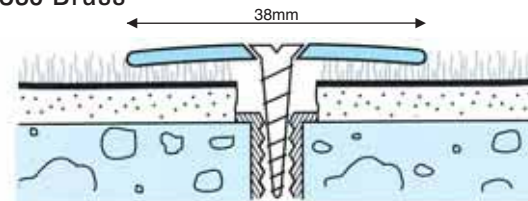

#### BC55 Brass

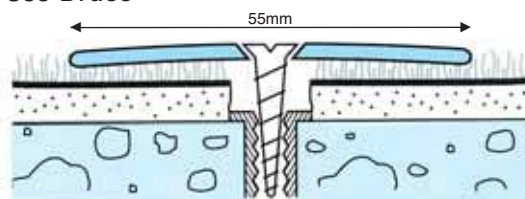

#### BEP plates



can be supplied with or without bevelled edges

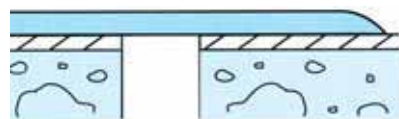

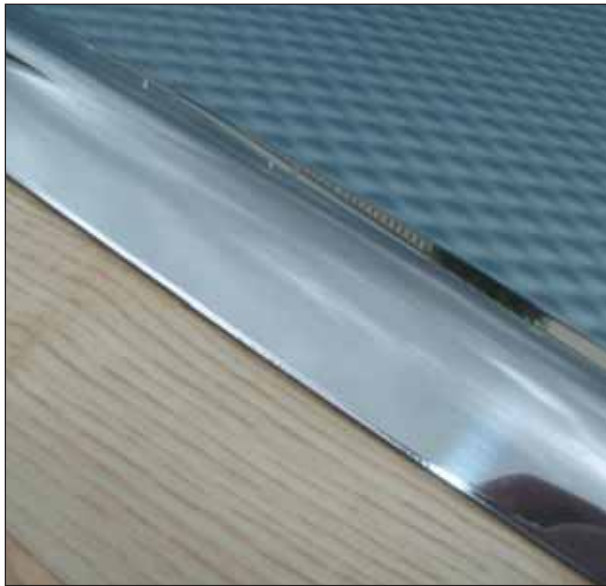

**Stainless Steel Cover Plates**  
**Supplied centre drilled** for mechanical fixings. Available undrilled and offset drilled upon request.

SC30

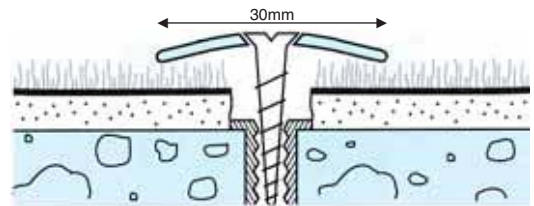

SC38

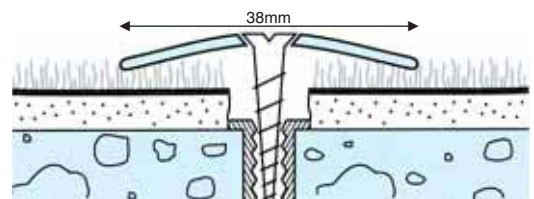

SC55

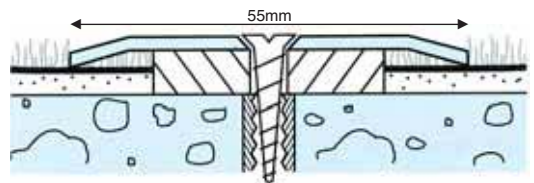

S155

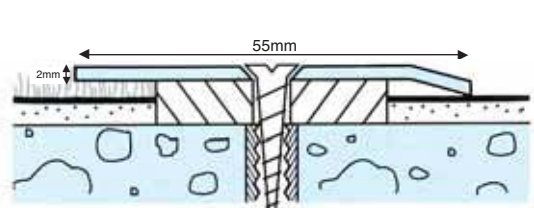

SC60

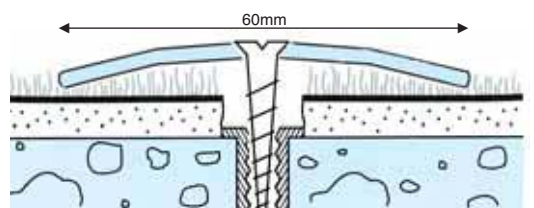

### Finishes available

Please refer to the special finishes page for more information

Bright • Brushed

### Stock lengths:

2.0m x 6 = Packed 12m

### SSEP plates

Available in Bright or Brushed finish



SSEP1 : 75mm wide

SSEP2 : 100mm wide

Wider plates can be made to special order.

please specify drilling when ordering  
 can be supplied with or without bevelled edges





2mm gauge flat plates produced in aluminium, brass and stainless steel.

Available with bevelled edges to order.

Drilling options for mechanical fixings.

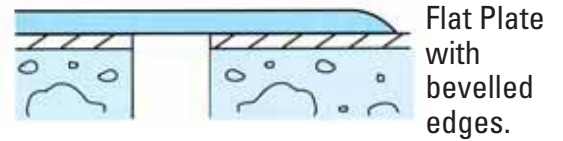
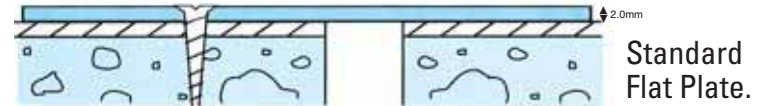

Stock lengths: 2.0m x 6 = Packed 12m

## Drilling Options

### Centre Drilled

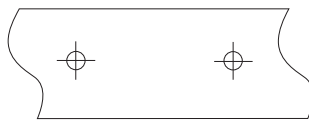

### Offset Drilled



### Stagger Drilled

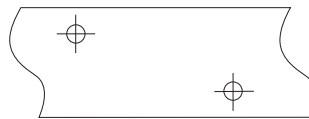

Width	Aluminium	Brass	Stainless Steel
75mm	AEP1	BEP1	SSEP1
100mm	AEP2	BEP2	SSEP2
150mm	AEP3	BEP3	SSEP3

Other sizes to special order.

### AC45 - feature plate

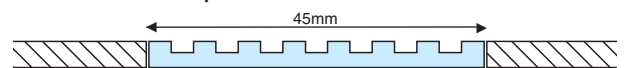

- Mill Aluminium
- Polished Aluminium
- Satin Aluminium

## SMALL FLAT PLATES

Supplied in mill finish, undrilled

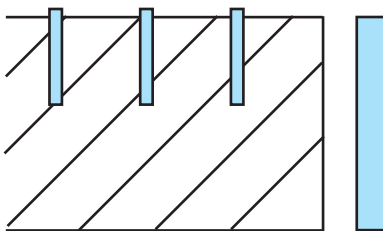

Size	Aluminium	Brass	Stainless Steel
10x3	FPA 10x3	FPB 10x3	
10x4			FPSS 10x4
10x6	FPA 10x6	FPB 10x6	
12x3	FPA 12x3	FPB 12x3	
12x5			FPSS 12x5
	Stock Lengths 2.5m x 12 = 30m	Stock Lengths 1.83m x 6 = 10.98m	Stock Lengths 2m x 12 = 24m



## TRANSITION PLATES

20



Extruded aluminium transition plates with pvc infills for concealed fixings.

Supplied centre drilled for mechanical fixings.

Available undrilled or offset drilled on request.

T80i and T78i plates are supplied pre taped for retro fit pvc infills to conceal screw fixings.

### Finishes

T80i Silver anodised matt  
T78i Mill • Satin

### Stock lengths:

2.715m x 6 = Packed 16.29m

T80i Suitable for use with all types of flooring including timber, ceramics, carpet and resilient floorings.

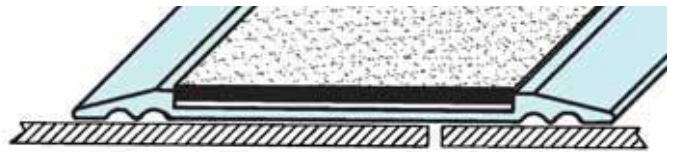
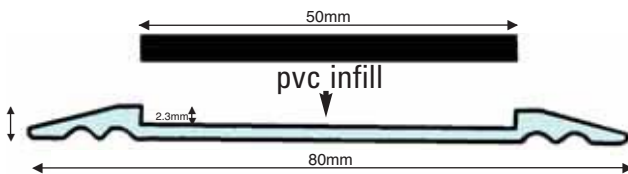

T78i with matching resilient flooring insert



T78i with pvc infill

T78i Suitable for use with resilient floorings to 3mm in depth. With the installation of a suitable packer, other floorings can be accommodated.

T78i is available without infill tape on request.

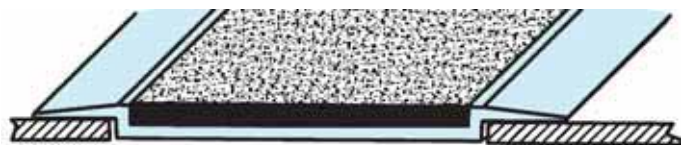
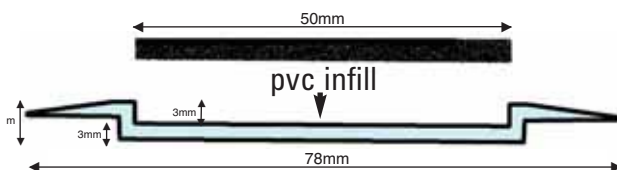

### Choice of infill colours

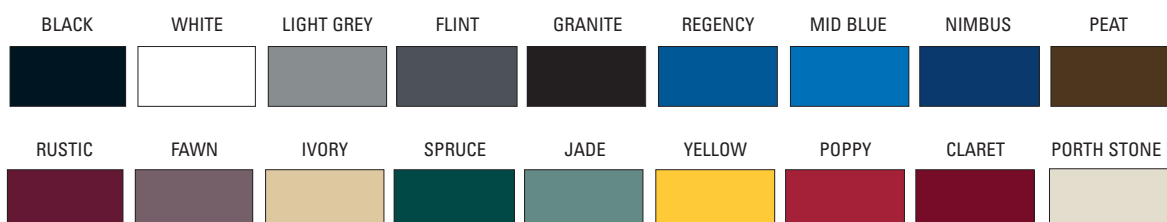



Finishing trims - where one type of flooring is higher than another adjoining floor.

**Ceramics • Laminate • Carpet tiles • Barrier Mats**

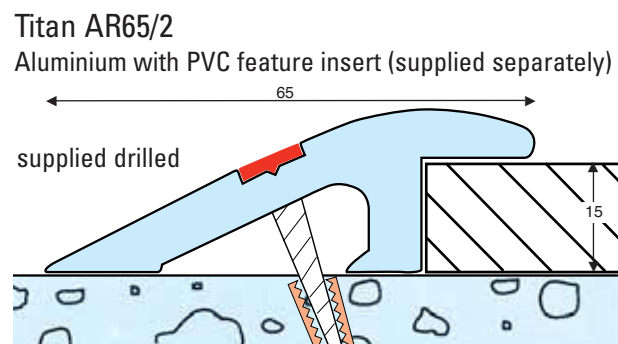
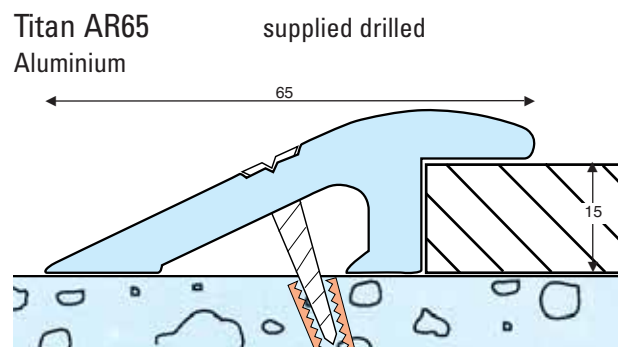
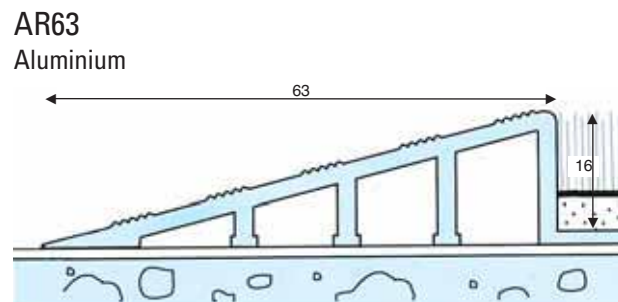
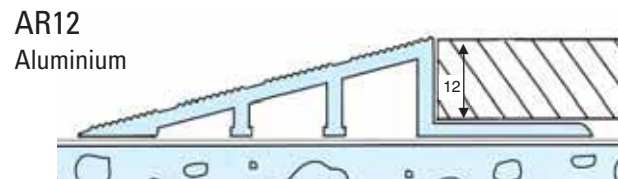
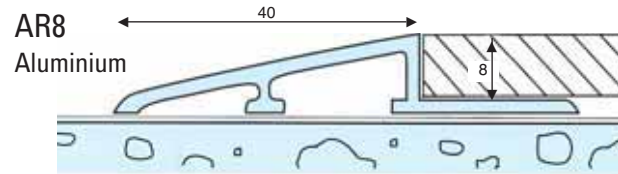

### Finishes available

Refer to the special finishes page for more information

### Aluminium Trims

- Mill finish
- Satin
- Polished
- Silver Anodised

### Stock lengths:

Aluminium: 2.715m x 6 = Packed 16.29m



Finishing trims - where one type of flooring is higher than another adjoining floor.

**Ceramics • Laminate • Timber**

BR9 Brass  
SR9 Stainless Steel

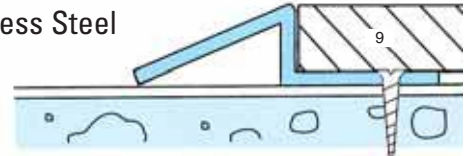

BR14 Brass  
SR14 Stainless Steel

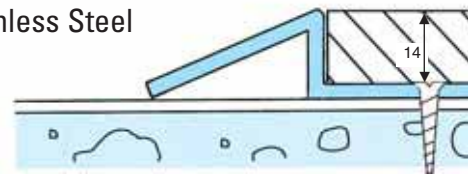

FTRS12 Stainless Steel

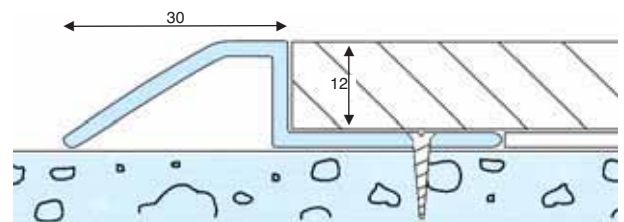

BR8 Brass  
SR8 Stainless Steel

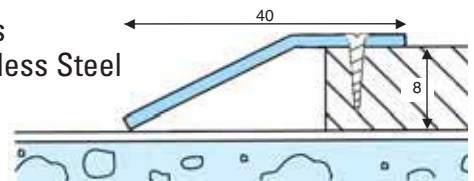

BR12 Brass  
SR12 Stainless Steel

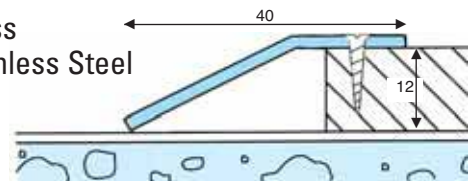

BR20 Brass  
SR20 Stainless Steel

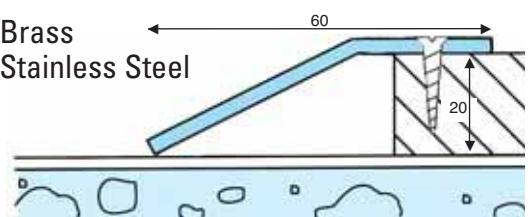

### Finishes available

Refer to special finishes page for more information.

### Brass Trims available in special finishes

Antique brass • Antique bronze

### Stainless Steel Trims

Bright • Brushed

### Stock lengths:

Brass: 2.0m x 6 = Packed 12m

Stainless Steel: 2.0m x 6 = Packed 12m

(BLE 2.715m x 6 = Packed 16.29m)

### Lino Edges

BLE  
Brass

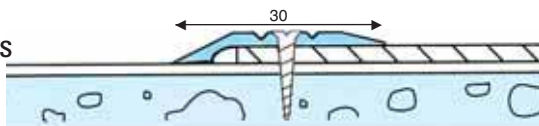

SLE  
Stainless Steel

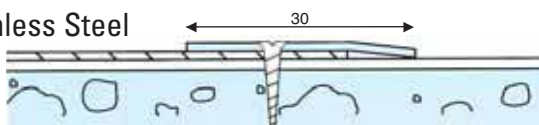

All sections supplied drilled. Available undrilled to special order.



## ANGLES AND FORMABLE TAG TRIM





## Aluminium Angles

### Application

Where a neat straight edge is preferred between floor coverings.

Typical applications include ceramics, carpet tiles, matwell frames and vinyl floors. For curved areas Tag Trim TT, profiles are required.

Polished top edges and drilled bases

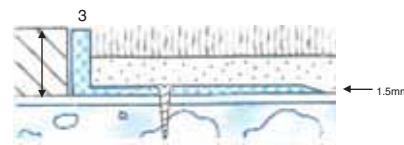

#### Product Codes

- A3
- A4.5
- A6.5
- A9
- A13
- A16
- A19
- A22.5
- A25

Product code numbers denote external upstand height in millimetres.

### Symbols

A – Aluminium

TT – Tag Trim = Formable



## Formable Aluminium Angles

Tag Trim profiles can be formed on site to allow freedom of design where a neat edge is preferred between floor coverings.

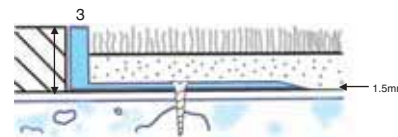

#### Product Codes

- TTA3
- TTA4.5
- TTA6.5
- TTA9
- TTA13
- TTA16
- TTA19
- TTA22.5
- TTA25

Product code numbers denote external upstand height in millimetres.

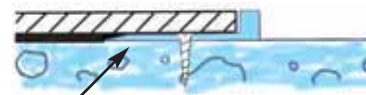

Notched base for ease of curving

*Tag Trim is an ever increasing brand, for sizes and finishes not shown call our sales office for advice.*

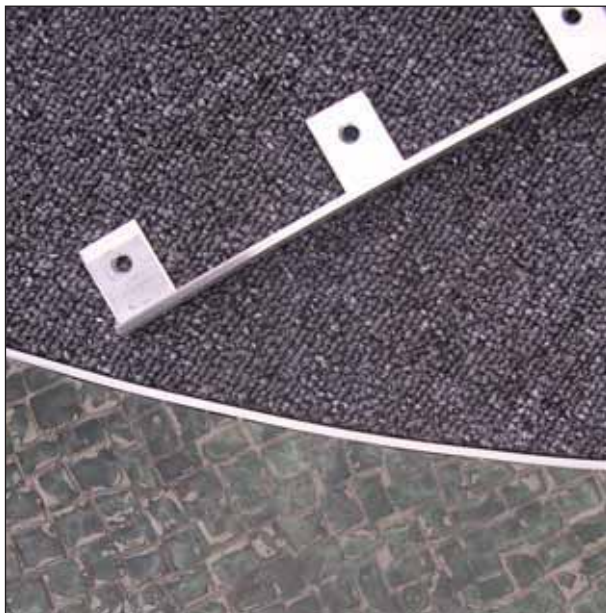

Stock lengths: 2.715m x 6 = Packed 16.29m

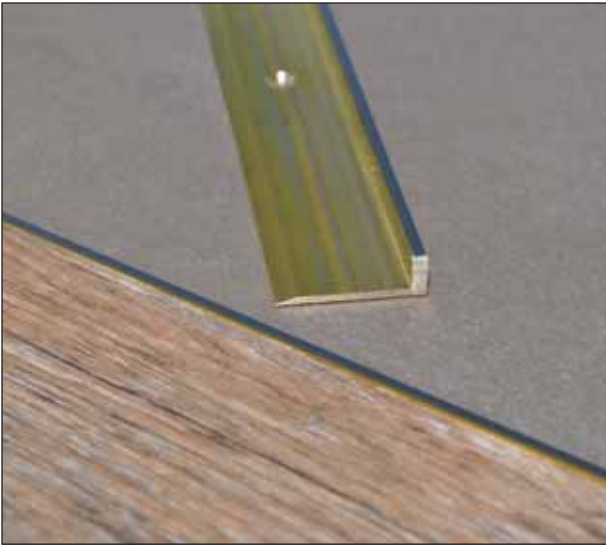

## Brass Angles

Polished Top Edges and Drilled Bases

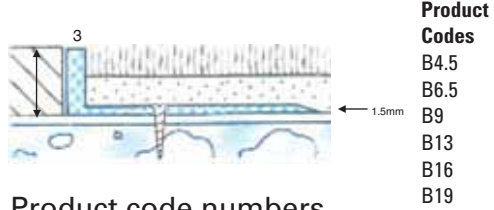

Product code numbers denote external upstand height in millimetres.

### Symbols

- B - Brass
- TT - Tag Trim = Formable

### Special Finishes available to order

Antique Bronze • Antique Brass Top edge

### Equal Angles

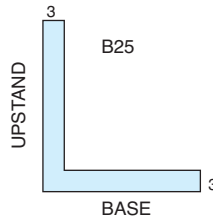

### HD = Heavy Duty

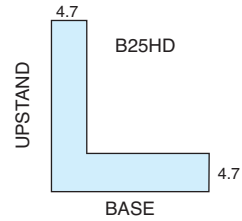

B25 HD

**Stock lengths:**

1.83m x 6 = packed 10.98m



## Formable Brass Angles

Tag Trim profiles can be formed on site to allow freedom of design where a neat edge is preferred between floor coverings.

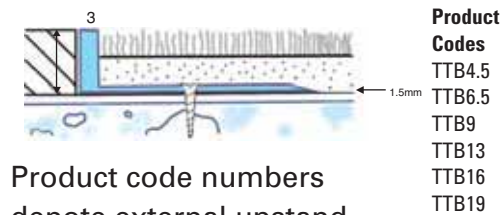

Product code numbers denote external upstand height in millimetres.

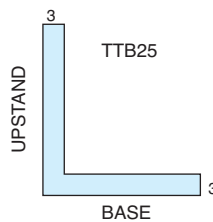

**Stock lengths:** 2.715m x 6 = Packed 16.29m



## Stainless Steel Angles

Polished top edges and drilled bases

## Folded Angles

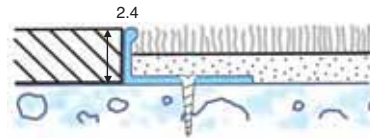

Product code numbers denote external upstand height in millimetres.

**Product Codes**  
 S6.5  
 S9  
 S12  
 S16  
 S19  
 S22  
 S25

## FTS10 - Feature Trim



### Symbols

- S - Stainless Steel
- TT - Tag Trim = Formable



## Formable Steel Angles

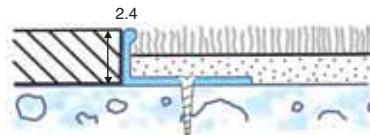

Product code numbers denote external upstand height in millimetres.

**Product Codes**  
 TTS6.5  
 TTS9  
 TTS12  
 TTS16  
 TTS19  
 TTS22  
 TTS25

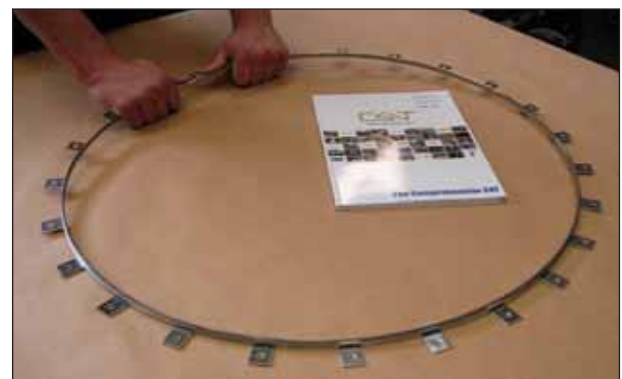

Stock lengths: 2.0m x 6 = Packed 12m

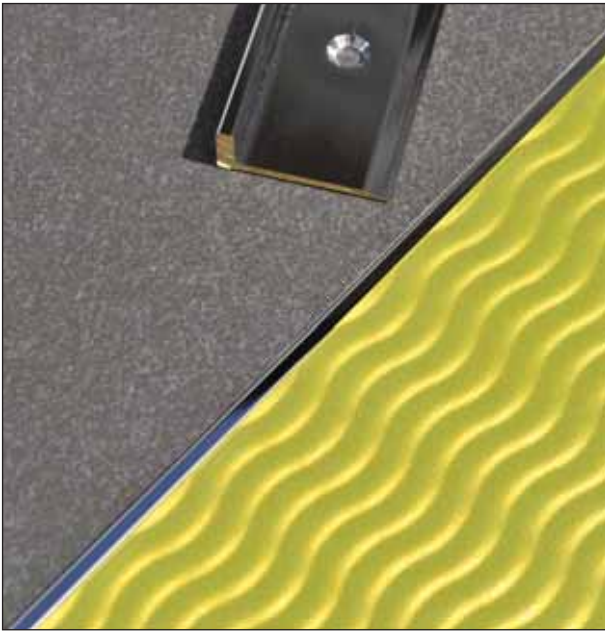

Premier Chrome Finish for prestigious installations.

**Symbols**

- C – Chrome
- TT – Tag Trim = Formable



## Chrome Angles

Bright chrome top edge and drilled bases

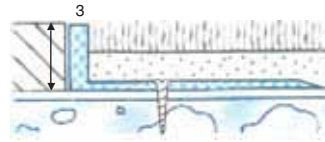

- Product Codes**
- C6.5
  - C9
  - C13
  - C16

Product code numbers denote external upstand height in millimetres.

## Formable Chrome Angles

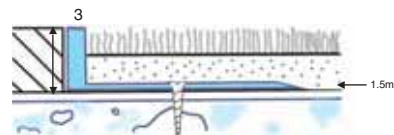

- Product Codes**
- TTC6.5
  - TTC9
  - TTC13
  - TTC16

Product code numbers denote external upstand height in millimetres.

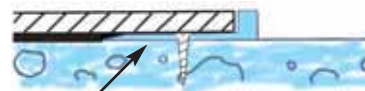

Notched base for ease of curving

**Stock lengths:** 2.715m x 6 = Packed 16.29m



**Popular with timber and ceramic floors**

Timberline allows for expansion and provides a neat covering for raw cut edges

**Timberline 1**

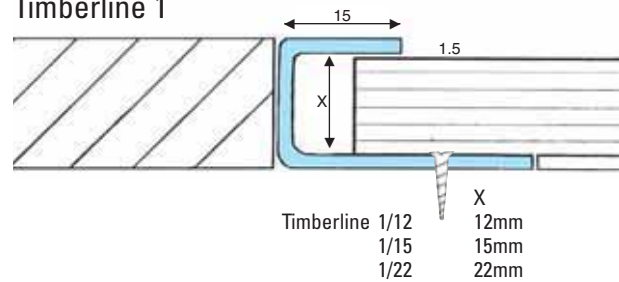

**Timberline 2**

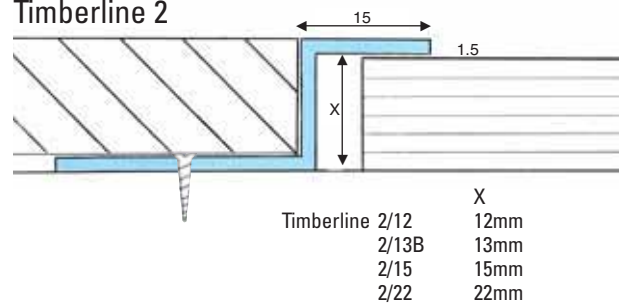

**Timberline 3**

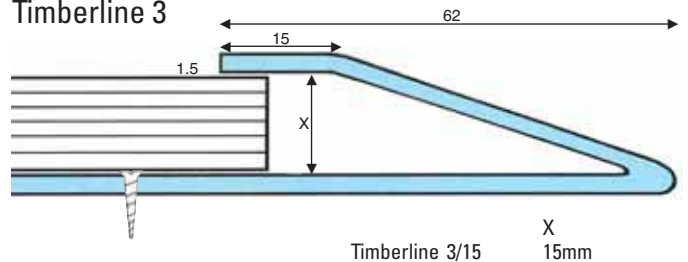

**Timberline 4**

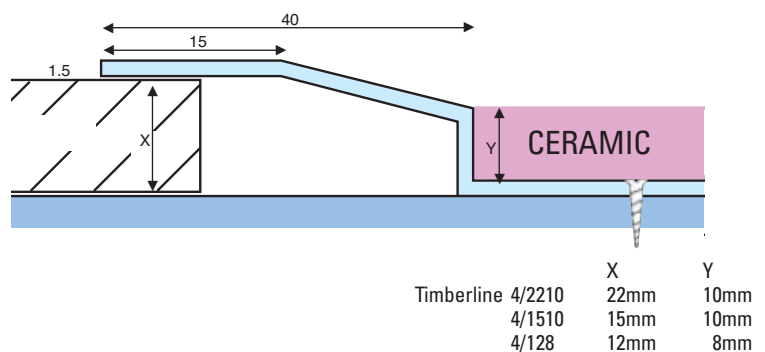

**Metal References**

- B – Brass
- S – Stainless Steel

Stainless Steel available in bright and brushed finish

**Special finishes to order on Brass**  
 Refer to special finishes page for more information.  
 Antique bronze  
 Antique brass

**Stock lengths:**  
 2.0m x 6 = Packed 12m  
 Supplied drilled



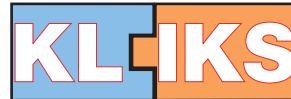

## Twin Profiles

KLIKS Twin Profile is designed to join two floor coverings of the same height and protect cut edges of flooring.

Ideal for joining ceramic, timber, laminate floors and any other floor type requiring expansion.

Suitable for residential and contract use for flooring heights between 9.5mm-23mm using the bases shown below.

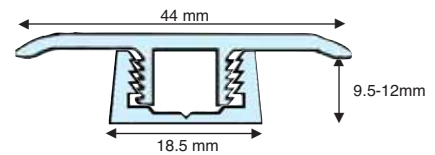

KLIKS Twin Profile with KB1 base

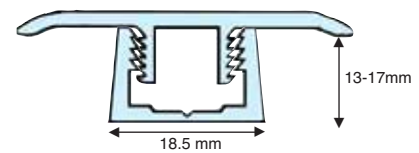

KLIKS Twin Profile with KB2 base

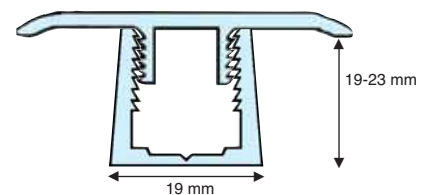

KLIKS Twin Profile with KB3 base

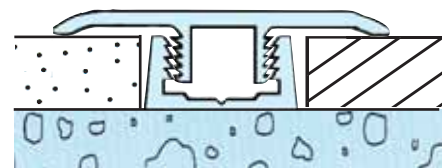

### Stock lengths:

2.715m x 6 = Packed 16.29m

Tops and bases are supplied separately.

### Finishes available

- KK102 Aluminium Silver
- KK112 Mill Aluminium
- KK122 Polished Aluminium
- KK132 Satin Aluminium
- KK2 Brass
- KK202 Antique Brass
- KK212 Antique Bronze
- KK222 Chrome
- KK232 Nisheen
- KK242 Satin Chrome
- KK252 Nickel
- KK2 Black Chrome max 0.900m length
- KK2 Pearl Chrome



Aluminium Chrome 0.900m x 6 = Packed 5.4m

KK142 Aluminium Chrome

KK152 Aluminium Satin Chrome

Refer to special finishes page of the Comprehensive CAT for more information.

**Bases supplied pre-drilled for mechanical and adhesive fixing.**



## Ramp Profiles

Where a profile is required to accommodate situations where one flooring meets another of a different height.

Ideal for timber, ceramics, carpets, laminates, terrazzo and any floor covering requiring expansion.

Using a suitable base shown below will allow you flexibility with flooring heights.

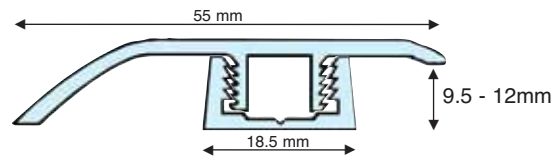

KLIKS Ramp profile with KB1 Base

### Stock lengths:

2.715m x 6 = Packed 16.29m

Tops and bases are supplied separately.

### Finishes available

- KK103 Aluminium Silver
- KK113 Mill Aluminium
- KK123 Polished Aluminium
- KK133 Satin Aluminium
- KK3 Brass
- KK203 Antique Brass
- KK213 Antique Bronze
- KK223 Chrome
- KK233 Nisheen
- KK243 Satin Chrome
- KK253 Nickel
- KK3 Black Chrome max 0.900m length
- KK3 Pearl Chrome

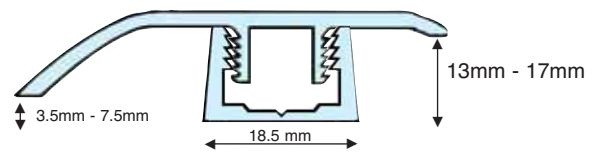

KLIKS Ramp profile with KB2 Base

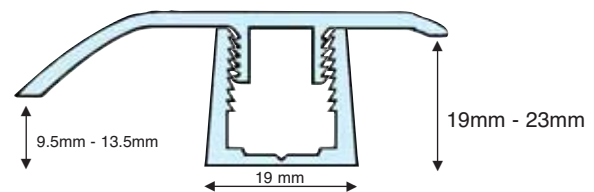

KLIKS Ramp profile with KB3 Base

Aluminium Chrome 0.900m x 6 = Packed 5.4m

KK143 Aluminium Chrome

KK153 Aluminium Satin Chrome

Refer to special finishes page of the Comprehensive CAT for more information.

**Bases supplied pre-drilled for mechanical and adhesive fixing.**



## Large Ramp Profiles

Where a profile is required to accommodate situations where one flooring meets another of a different height. Ideal for timber, ceramics and any floor requiring expansion. Using a suitable base will allow you flexibility with flooring heights.

### Stock lengths:

2.715m x 6 = Packed 16.29m

Tops and bases are supplied separately.

### Finishes available

- KK104 Aluminium Silver
- KK114 Mill Aluminium
- KK124 Polished Aluminium
- KK134 Satin Aluminium



Refer to special finishes page of the Comprehensive CAT for more information.

**Bases supplied pre-drilled for mechanical and adhesive fixing.**

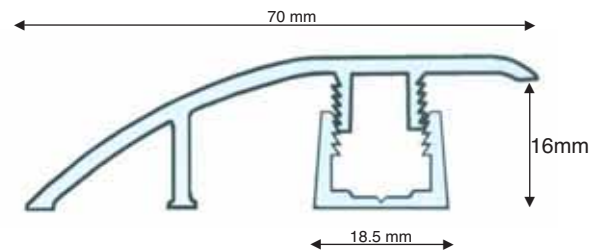

KLIKS Large Ramp Profile with KB2 Base

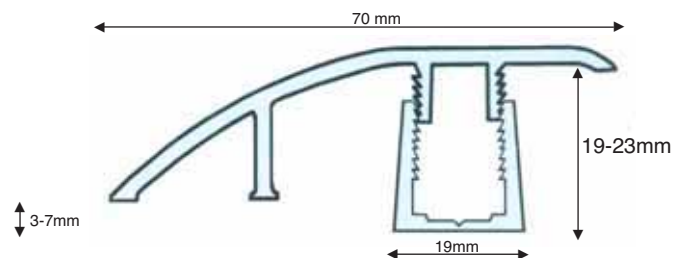

KLIKS Large Ramp Profile with KB3 Base



## End Stop Profiles

To finish the edge of a floor either at the perimeter or at a junction.  
Ideal for timber, ceramic, carpet, laminate and floor coverings requiring expansion against skirtings, walls or hard floor coverings.

Suitable for flooring heights between 9.5-23mm using the bases shown below.

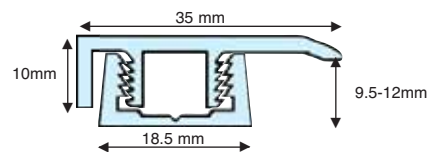

KLIKS End stop with KB1 base

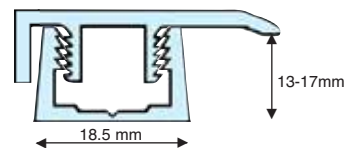

KLIKS End stop with KB2 base

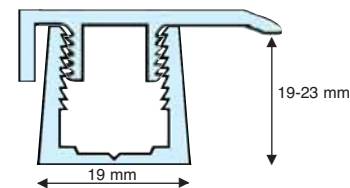

KLIKS End stop with KB3 base



### Stock lengths:

2.715m x 6 = Packed 16.29m  
Tops and bases are supplied separately.

### Finishes available

- KK101 Aluminium Silver
- KK111 Mill Aluminium
- KK121 Polished Aluminium
- KK131 Satin Aluminium

Aluminium Chrome 0.900m x 6 = Packed 5.4m

- KK141 Aluminium Chrome
- KK151 Aluminium Satin Chrome

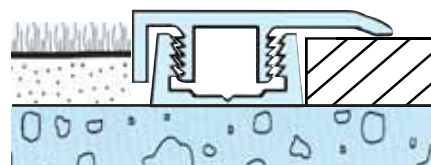

Refer to special finishes page of the Comprehensive CAT for more information.

**Bases supplied pre-drilled for mechanical and adhesive fixing.**



KLIK Spectrum is a co-extruded upvc range of profiles that allow specifiers to choose from an extensive selection of colours to compliment many interior designs. If your project requires a special colour, for a minimum quantity of approx 200 mtrs, KLIK Spectrum can be manufactured to a colour of your choice. Pictured below is the extensive range of Standard colours available.



Special project colour  
Please contact our Sales Office for more information

Colours depicted are representative only and are subject to printing interpretations - for a sample please contact our sales office.  
When specifying KLIK Spectrum state the colour required after the product code. i.e. KSP5 Granite or KSP6 Granite.

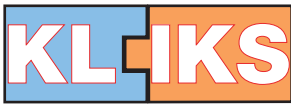

KLIKS profiles have been designed for simple installation. With versatile height adjustment and pre drilled bases the Spectrum range is quick and easy to install.



### Stage 1.

Bases are secured to sub floor with a suitable cartridge adhesive and No.6 countersunk screws.



### Stage 2.

Once the base is firmly secured to the sub floor, the flooring can be laid up to the base section.

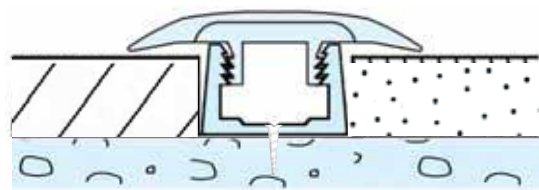

### Stage 3.

The top section may then be fitted by hand or using a soft mallet if necessary.

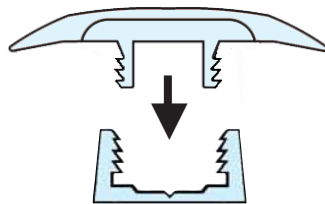

### Joints

The base profile joints should be staggered with a minimum overlap of 150mm, wherever possible, position the joints away from main traffic areas.

## Spectrum UPVC PROFILES

### Installation Environment

Care should be taken that the profiles are not fitted or stored, prior to fitting, in extreme conditions of cold or warmth. The ideal conditions for fitting are with temperatures in the range of 15°C - 25°C. Allowing a period of acclimatisation will assist in achieving a satisfactory result.

Ensure that when fitting the tops into the bases, the profile section is not heated with hot air guns/hot water, which can lead to the material being inadvertently stretched whilst being fitted into position. If the profiles are stretched during installation they will over time, revert to their original size, leaving gaps at the joints and ends.

When using the profiles in curved situations it is recommended that an adhesive fix be also applied into the base (50mm along) at the joints.

A selection of bases are available that include aluminium and UPVC bases depending upon the installation.



- Install aluminium bases with Spectrum ZIP tops only.

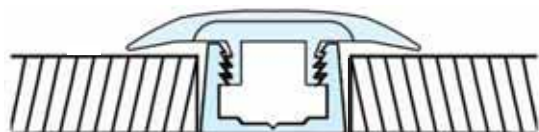

- Install UPVC bases with all KLIK metal and Spectrum ZIP tops.

**For further information please contact our sales office.**



KLIKS Spectrum Zip Twin top is a co-extruded profile, and when used with u-PVC bases allows for versatility and a smooth transition between floor coverings of different heights

### Typical Applications

**Typical Applications:** Carpet tile to laminate, carpet to stone, wood to carpet and ceramic to terrazzo.

**Environments:** Suitable for light, medium and heavy traffic installations i.e. dance floors, nightclubs, offices and retail stores.

**Stock lengths: Tops and bases**  
2.715m x 6=Packed 16.29m

Tops and bases are supplied separately.

u-PVC bases are supplied drilled.

When specifying profile required please state colour after product code i.e. KSP5 Black.

Please see page 34 for colour availability.



### Maintenance

PVC flooring profiles should be cleaned with a mild detergent with water on a damp - not wet - cloth, ensuring that the profile is wiped dry before allowing traffic to return to area.

**Polishes and industrial cleaning agents should not be used on PVC flooring profiles.**

KSP5  
KB1 upvc bases

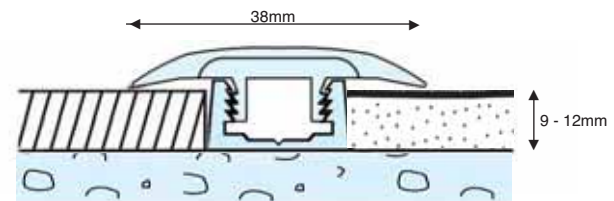

Laminate to Carpet tile

KSP5  
KB2 upvc base

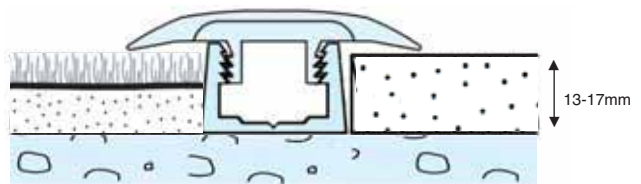

Carpet to stone

KSP5  
KB3 upvc base

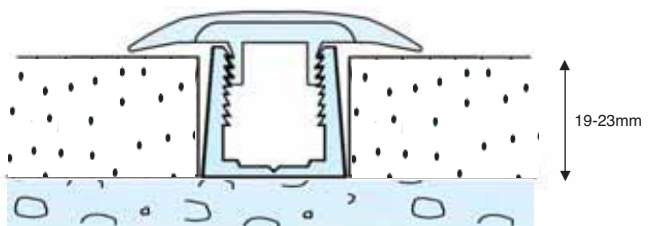

Ceramic to terrazzo

Select base dependant on height of floor covering



KSP5 ZIP Twin top can be used with Aluminium bases for installations where a curve is not required.

It is ideal for situations where easy removal and replacement is required.

### Typical Applications

KSP5 ZIP  
KAB 38 punched Base

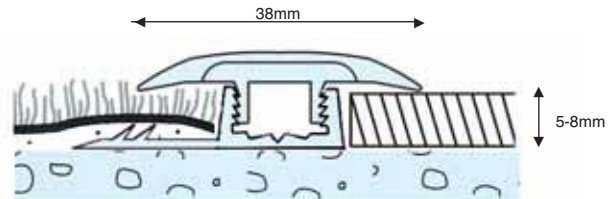

Carpet to ceramic

KSP5 ZIP  
KAB 60 punched base

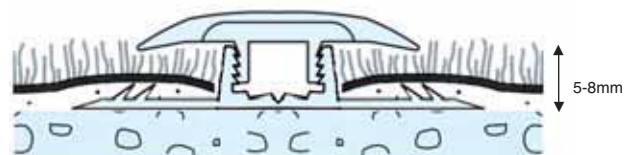

Carpet to carpet

KSP5 ZIP  
KAB 38 unpunched base

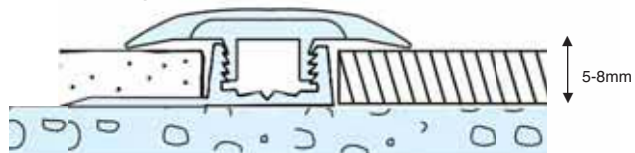

Carpet tile to laminate

**Typical Applications:** Carpet to carpet, carpet to stone, wood to carpet and carpet to ceramic.

**Environments:** Suitable for light, medium and heavy traffic installations i.e. dance floors, nightclubs, offices and retail stores.

**Stock lengths: Tops and bases**  
2.715m x 6=Packed 16.29m

Tops and bases are supplied separately.

Please specify punched or unpunched when ordering aluminium bases.

When specifying profile required please state colour after product code i.e. KSP5 ZIP Black.

Please see page 34 for colour availability.



### Maintenance

PVC flooring profiles should be cleaned with a mild detergent with water on a damp - not wet - cloth, ensuring that the profile is wiped dry before allowing traffic to return to area.

**Polishes and industrial cleaning agents should not be used on PVC flooring profiles.**



## KLIK S ZIP RAMP



KLIK S Spectrum ZIP Ramp top is a co-extruded profile, and when used with u-PVC bases allows for versatility and a smooth transition between floor coverings of different heights

### Typical Applications

**Typical Applications:** Carpet tile to laminate, carpet to stone, wood to carpet and ceramic to terrazo.

**Environments:** Suitable for light, medium and heavy traffic installations i.e. dance floors, nightclubs, offices and retail stores.

**Stock lengths: Tops and bases**  
2.715m x 6=Packed 16.29m

Tops and bases are supplied separately.

u-PVC bases are supplied drilled.

When specifying profile required please state colour after product code i.e. KSP6 Black.

Please see page 34 for colour availability.



KSP6  
KB1 upvc bases

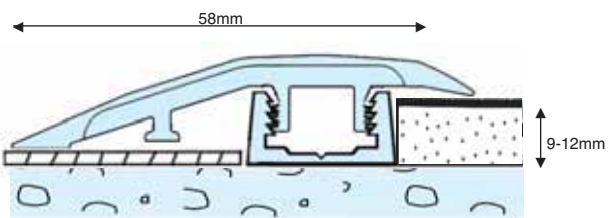

Vinyl to carpet tile

KSP6  
KB2 upvc base

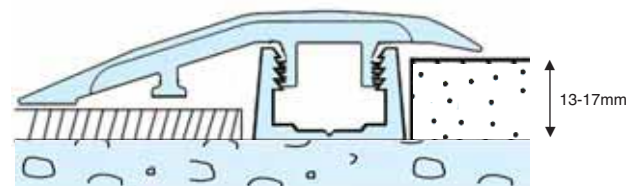

Vinyl to stone

KSP6  
KB3 upvc base

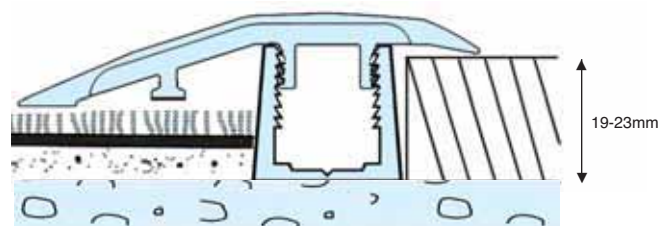

Carpet to wood floor

Select base dependant on height of floor covering

### Maintenance

PVC flooring profiles should be cleaned with a mild detergent with water on a damp - not wet - cloth, ensuring that the profile is wiped dry before allowing traffic to return to area.

**Polishes and industrial cleaning agents should not be used on PVC flooring profiles.**



KSP6 ZIP Ramp top can be used with Aluminium bases for installations where a curve is not required.

It is ideal for situations where easy removal and replacement is required.

**Typical Applications:** Carpet to stone, carpet to lino and carpet to vinyl.

**Environments:** Suitable for light, medium and heavy traffic installations i.e. dance floors, nightclubs, offices and retail stores.

**Stock lengths: Tops and bases**  
2.715m x 6=Packed 16.29m

Tops and bases are supplied separately.

Please specify punched or unpunched when ordering aluminium bases.

When specifying profile required please state colour after product code i.e. KSP6 ZIP Black.

Please see page 34 for colour availability.



### Typical Applications

KSP6 ZIP  
KAB 38 punched Base

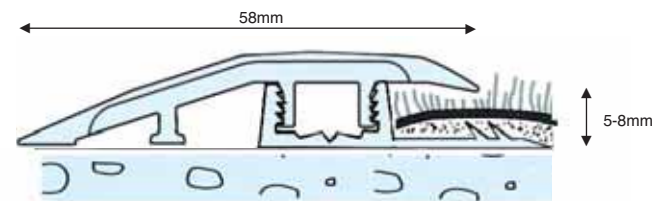

Stone to carpet

KSP6 ZIP  
KAB 38 unpunched Base

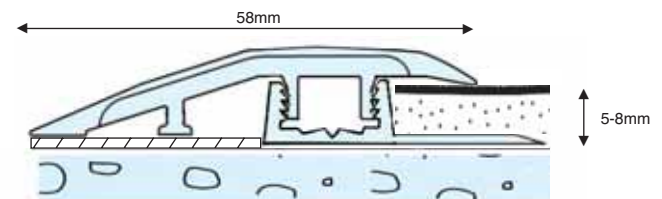

Lino to carpet tile

KSP6 ZIP  
KAB 38 punched Base

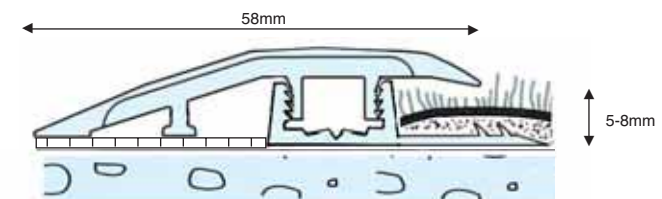

Vinyl to carpet

### Maintenance

PVC flooring profiles should be cleaned with a mild detergent with water on a damp - not wet - cloth, ensuring that the profile is wiped dry before allowing traffic to return to area.

**Polishes and industrial cleaning agents should not be used on PVC flooring profiles.**



KLIKS Spectrum end stop is a co-extruded profile, and when used with u-PVC bases allows for versatility and a smooth transition between floor coverings of different heights.

## Typical Applications

KSP7  
KB1 upvc base

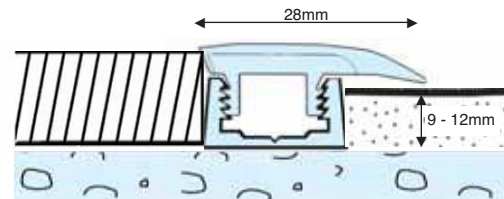

Laminate to Carpet tile

KSP7  
KB2 upvc base



Carpet to stone

KSP7  
KB3 upvc base

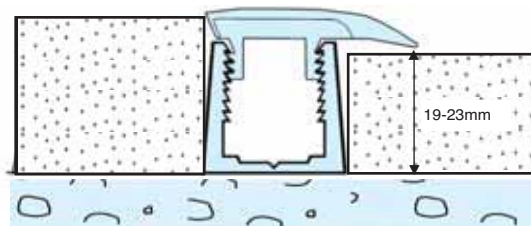

Ceramic to terrazzo

Select base dependant on height of floor covering

**Typical Applications:** Carpet tile to laminate, carpet to stone and ceramic to terrazzo.

**Environments:** Suitable for light, medium and heavy traffic installations i.e. dance floors, nightclubs, offices and retail stores.

**Stock lengths: Tops and bases**  
2.715m x 6=Packed 16.29m

Tops and bases are supplied separately.

u-PVC bases are supplied drilled.

When specifying profile required please state colour after product code i.e. KSP7 Black.

Please see page 34 for colour availability.



## Maintenance

PVC flooring profiles should be cleaned with a mild detergent with water on a damp - not wet - cloth, ensuring that the profile is wiped dry before allowing traffic to return to area.

**Polishes and industrial cleaning agents should not be used on PVC flooring profiles.**



For fast forming curves on site



KLKS Spectrum ZIP is a range of both twin and ramp top profiles that are curvable on site when used with uPVC bases. They are both very versatile so can be used with a wide range of floor coverings

**Typical Applications:** Carpet tile to laminate, carpet to stone, wood to carpet and ceramic to terrazo.

**Environments:** Suitable for light, medium and heavy traffic installations i.e. dance floors, nightclubs, offices schools and retail stores.

**Stock lengths: Tops and bases**  
2.715m x 6=Packed 16.29m

Tops and bases are supplied separately.

u-PVC bases are supplied drilled.

When specifying profile required please state colour after product code i.e. KSP5 Black.

Please see page 34 for colour availability.

**Typical Applications**

KSP5 ZIP  
KB2 uPVC Base

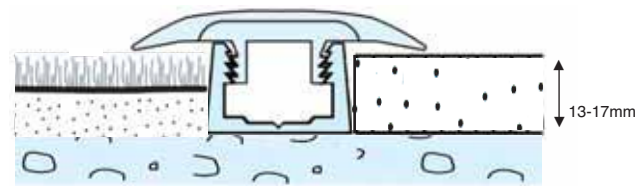

Carpet to stone

KSP6 ZIP  
KB2 uPVC Base

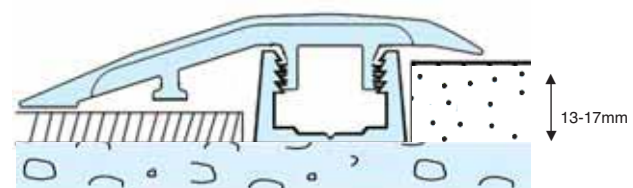

Vinyl to ceramic tile

Select base dependant on height of floor covering

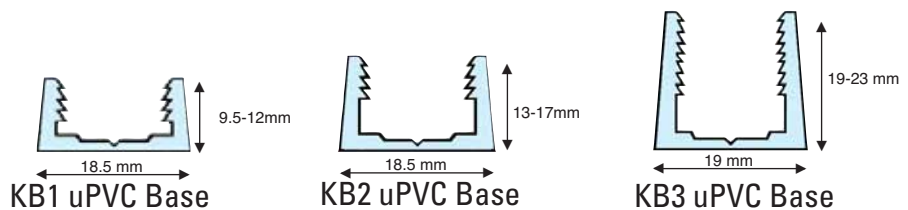

**Maintenance**

PVC flooring profiles should be cleaned with a mild detergent with water on a damp - not wet - cloth, ensuring that the profile is wiped dry before allowing traffic to return to area.

**Polishes and industrial cleaning agents should not be used on PVC flooring profiles.**



# CURVABILITY



The following table shows the minimum radii of KLIK Spectrum curves, when in a KB1 base, at normal room temperature.

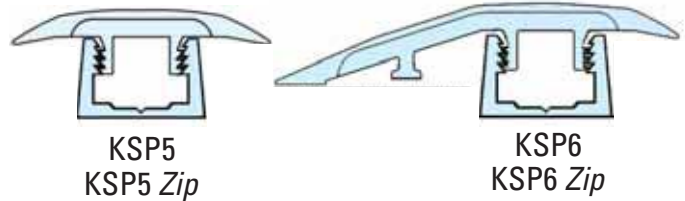

Profile	Radius (m)	Tail Position
KSP5 Zip	1.5m	
KSP6 Zip	1.5m	tail of ramp on the outer edge of circle
KSP6 Zip	1.7m	tail of ramp on the inside of circle



Profile	Radius (m)	Tail Position
KSP5	2.7m	
KSP6	2.3m	tail of ramp on the outer edge of circle
KSP6	2.5m	tail of ramp on the inside of circle

## Maintenance

PVC flooring profiles should be cleaned with a mild detergent with water on a damp - not wet - cloth, ensuring that the profile is wiped dry before allowing traffic to return to area.

**Polishes and industrial cleaning agents should not be used on PVC flooring profiles.**

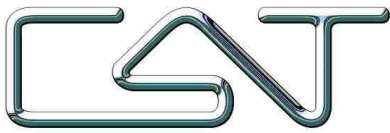

## Product Data Sheet: KSP73



### Kliks Spectrum Zip™



KSP73 Ramp top is a PVC extruded profile, and when used with the u-PVC bases, allows for a smooth, versatile transition between floor coverings of different heights.

#### Typical Applications

KSP73 and KB3

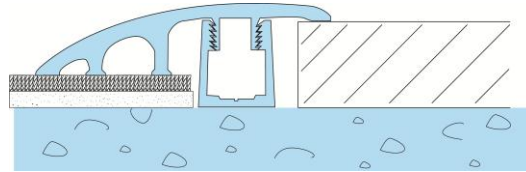

Low loop carpet to timber

KSP73 and KB2

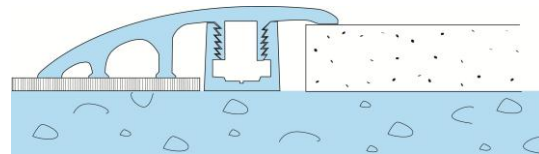

Lino to ceramic

KSP73 and KB2

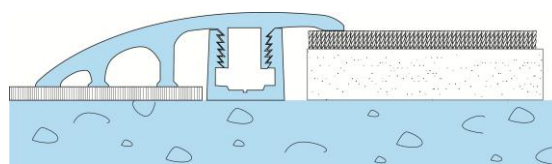

Vinyl to carpet

**Typical applications:** For use with engineered timber, solid wood, parquet, ceramics, porcelain and natural stone tiles.

Suitable for residential and contract use.

Tops and bases supplied separately.  
When ordering please specify colour i.e. KSP73 Black.

Packed: 2.715m x 6 = 16.29 metres

KSP73 is available in:

- Black
- Granite
- Peat
- Light Grey

*Other colours available subject to order quantity.*

#### Benefits include:

- Tops can be removed and replaced
- Versatile Height Adjustment
- Suitable for heavy traffic areas
- Curvable on site

#### Maintenance

PVC flooring profiles should be cleaned with water and mild detergent on a damp - not wet - cloth, ensuring that the profile has been wiped dry before allowing traffic to continue to the area.

**Polishes and industrial cleaning agents should not be used on PVC flooring profiles.**



**CATWALK CURVABLE PROFILES**





## Installation

Form base to shape of curve required and affix to sub floor (ensuring that surface is level) with a suitable adhesive and screw fixings.

When fitting lengths over 2.715m always overlap top joints by a minimum of 150cm over base joints.

Once base is firmly secured floorings can be laid and tops dressed in with a rubber mallet.

**Material must not be stretched when fitting as this will cause tops to contract and cause shrinkage.**



**Suitable for domestic and light to medium traffic installations**, typical applications include carpet to laminate and ceramic floors.

For contract areas with heavy traffic please contact the sales office for alternative products.

**Cat Walk** is an installation friendly PVC system designed for fast, easy curving of transition profiles on site.

Curvable to a minimum radius of 750mm, tops are available in twin top T36 and ramp top RT39 styles.

Cat Walk T36 Twin Top

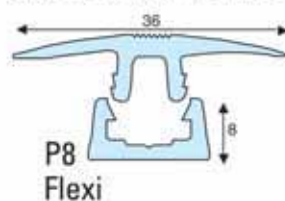

Cat Walk RT39 Ramp Top

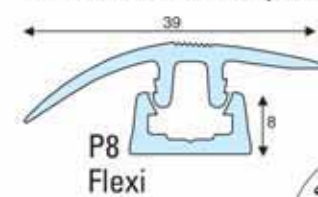

Typical application

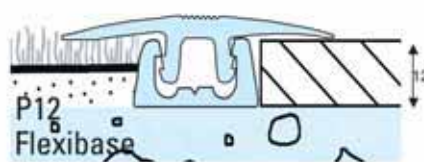
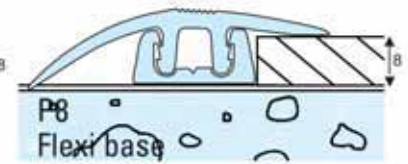

## Bases

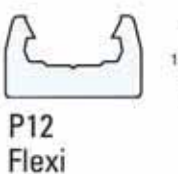
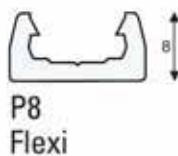

Select base dependent on height of floor covering

Bases are supplied pre-drilled

**Tops are available in the following stock colours:**

Black	
Granite	
Peat	

**Other colours available to 250 mtr minimum order**

## Stock lengths: - tops and bases

2.715m x 6 = Packed 16.29m

Tops and bases are supplied separately.



## Limited Stock



**Stock lengths: - tops and bases**  
2.715m x 6 = Packed 16.29m

## Aluminium Base

For use with Carpets. Suitable with all twin tops and P8 and P16 bases.

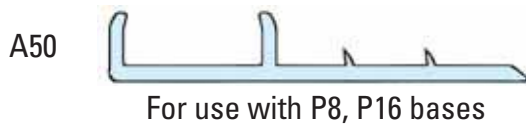
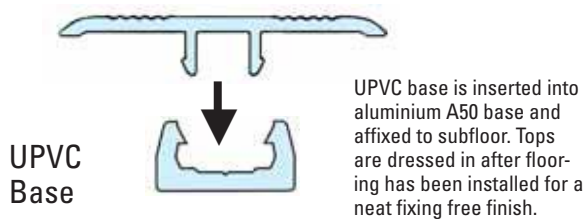

## A typical application of Timber to Carpet

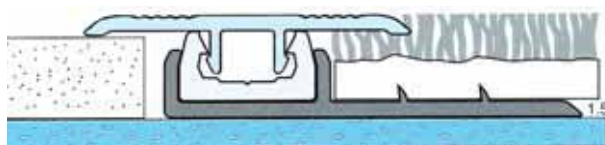

## Now Superseded by KLIKS Range



## Square edge and twin profiles

Top-on-base system "TOB" profiles can be used with various types of floorings including carpet, laminate, timber and ceramics.

### Square Edge

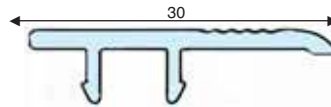

- TOB101 Aluminium Silver
- TOB111 Mill Aluminium
- TOB121 Polished Aluminium
- TOB131 Satin Aluminium

### Typical Applications

Ceramic - Carpet Tile  
Perimeter edged trim



### Twin

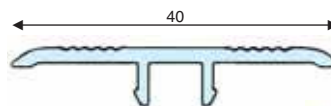

- TOB102 Aluminium Silver
- TOB112 Mill Aluminium
- TOB122 Polished Aluminium
- TOB132 Satin Aluminium

### Typical Applications

Timber - Timber  
Timber - Ceramic

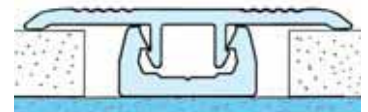

### Extra Wide Twin



Produced with a smooth top for a superb finish.

- offset top for expansion

- TOB105 Aluminium Silver
- TOB115 Mill Aluminium
- TOB125 Polished Aluminium
- TOB135 Satin Aluminium

## UPVC Bases

Predrilled for mechanical fixing to sub floor.

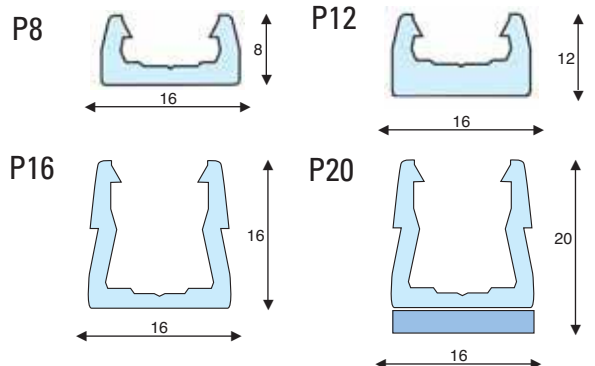

The use of a cartridge applied adhesive is recommended for bases.



## Limited Stock



Brass trims are available in special finishes

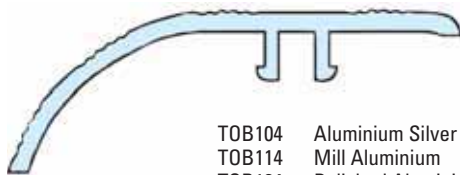

- TOB104 Aluminium Silver
- TOB114 Mill Aluminium
- TOB124 Polished Aluminium
- TOB134 Satin Aluminium

Clip profile into bases illustrated to create ramp heights as shown.

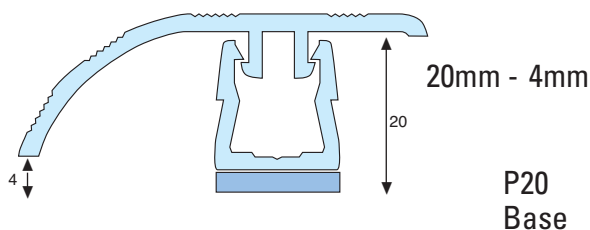
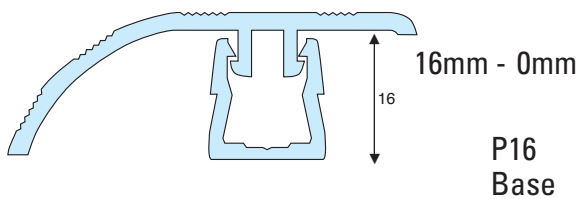

**Stock lengths: - tops and bases**  
2.715m x 6 = Packed 16.29m

## Now Superseded by KLIKS Range



### Ramp profiles

Ramp tops can be used with all TOB bases to accommodate situations where a flooring meets another flooring of a different height.

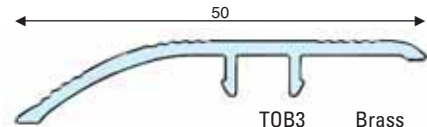

- TOB3 Brass
- TOB103 Aluminium Silver
- TOB113 Mill Aluminium
- TOB123 Polished Aluminium
- TOB133 Satin Aluminium

Clip profile into bases illustrated to create ramp heights as shown

### UPVC Bases

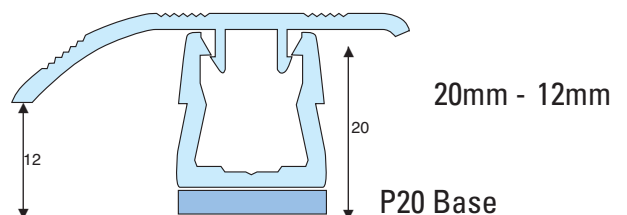
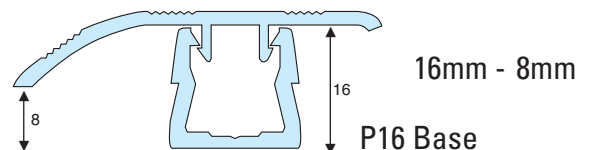
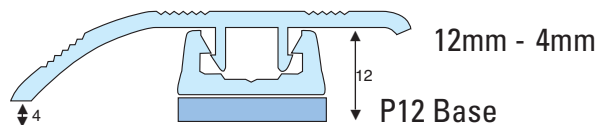
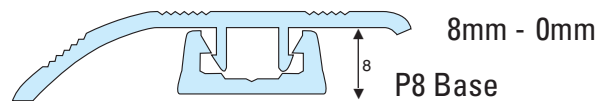

### Aluminium Base for Carpets

Suitable with P8 and P16 bases. Can also be used where a wider plate is required for fixing to sub floor.

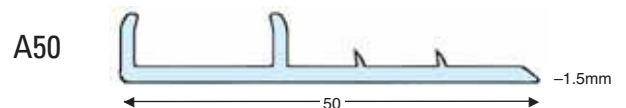

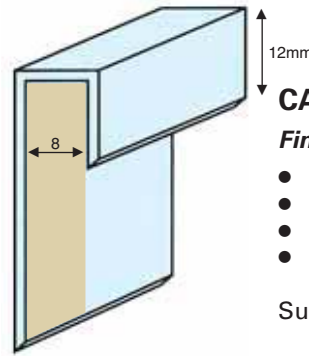

**CAP IT**

**Finishes**

- Mill aluminium
  - Polished aluminium
  - Silver anodised
  - Powder coat to special order - subject to quantities
- Supplied undrilled

**Application:**

Capping details for floorings where traditional timber skirtings are not preferred.

**Stock lengths:**

- Aluminium: 2.715m x 6 = Packed 16.29m
- Brass: 2m x 6 = Packed 12m
- Stainless Steel: 2m x 6 = Packed 12m

**Stainless Steel**

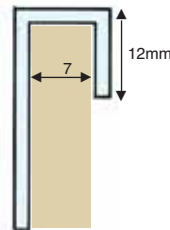

**SSE**

**Finishes**

- Bright finish
  - Brushed finish
- Supplied undrilled

**S CAP**

*For capping vinyl and linoleum floorings*

- Bright finish
  - Stainless steel
- Supplied undrilled

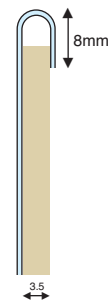

**Skirting Profiles**

Popular for installations requiring perimeter expansion of wooden floors, typically sports halls and large open areas.

**AC50/50 Aluminium**

**Finishes**

- Silver anodised

Supplied drilled.

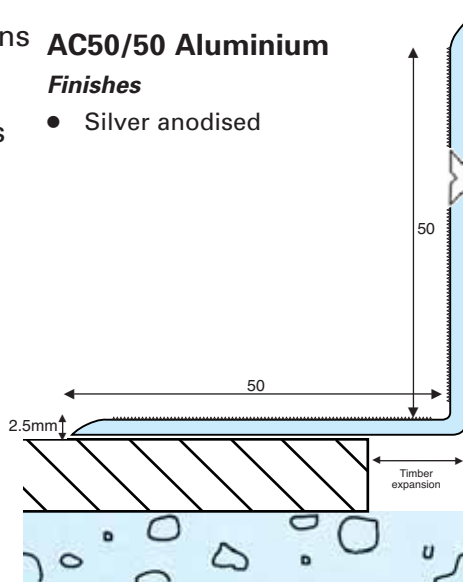

**SC50/50 Stainless Steel**

**Finishes**

- Bright
- Brushed

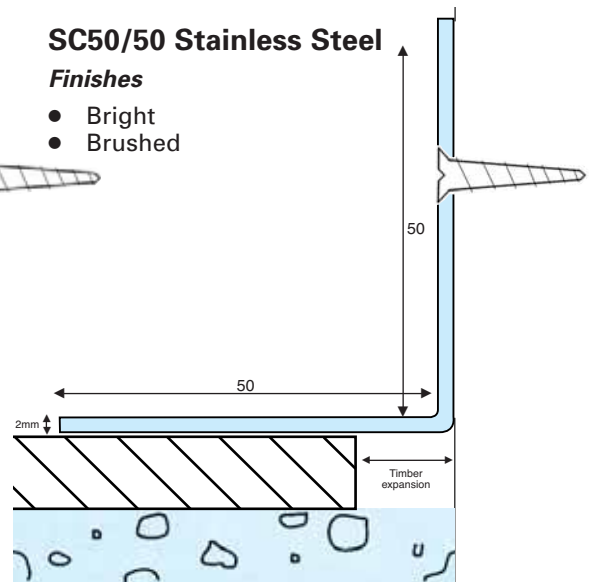

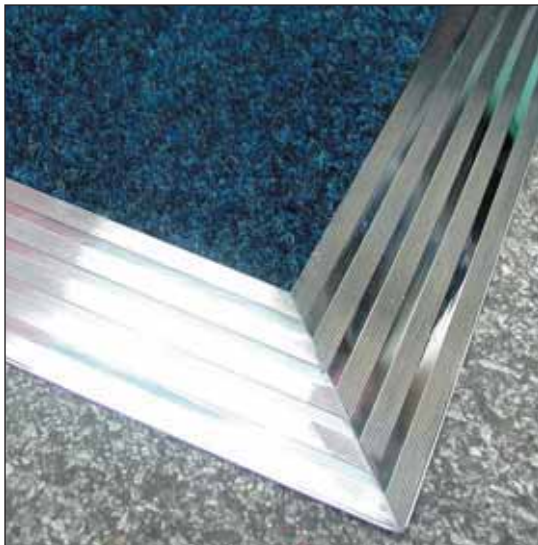

**(SF)** Surface fix frames example

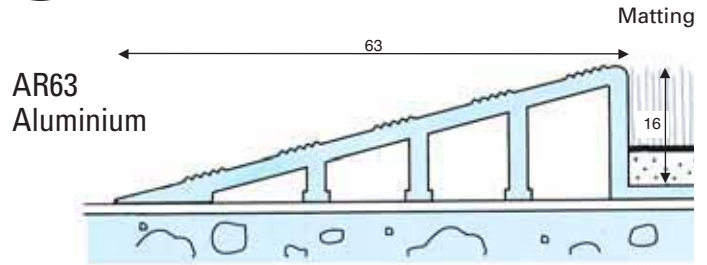

**(BF)** Base fix frames

- Polished top edge
- Mitred and drilled to customer's sizes
- Welded frames to special order

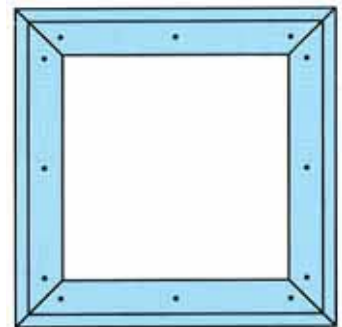

**Special Services**

- Circular and curved frames

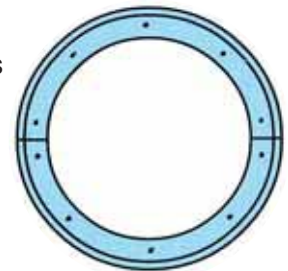
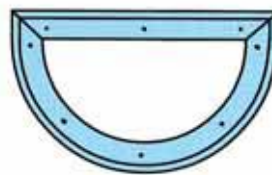

**PLEASE NOTE**

When ordering Matwell frames please specify either **(BF)** (base fix) or **(TF)** (top fix) styles.

**(BF)** frames are available in all CAT standard edgings and angles, produced with the base inwards unless otherwise indicated.

For circular frames a suitable plan is required or hardboard template.

**(TF)** frames are available in suitable angles shown.

**(SF)** frames are used when matting is fitted above the level of the finished floor.

For advice on suitable sections with various types of matting please call our sales office.

**(TF)** Top fix frames — Supplied drilled (in frames)

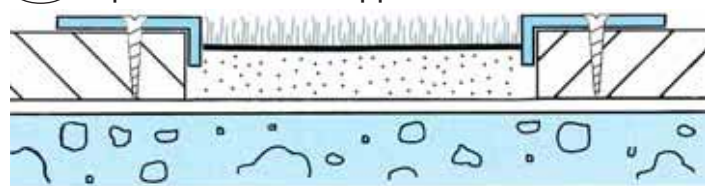

Suitable angles for **(TF)**

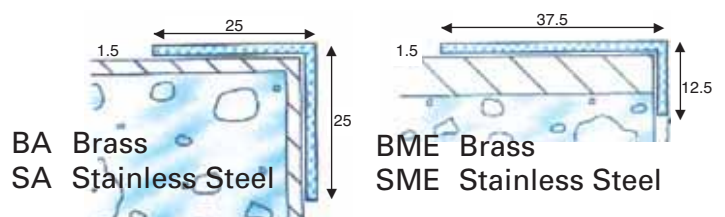

**Stock lengths:**

Brass: 1.83m x 6 = Packed 10.98m  
Stainless Steel: 2.0m x 6 = Packed 12m

**Orders for Matwell frames must be accompanied by a diagram indicating where measurements have been taken from and any tolerances required**



## CAT Gives you choice

For clients who require a superior finish to their installation



**Bright Chrome**



**Nickel**



**Satin Chrome**



**Nisheen**



**Pearl Chrome (special order)**



**Polished Brass**



**Black Chrome (special order)**



Chrome and Nickel plating is applied to Brass profiles to create superb finishes. Often selected as alternatives to Stainless Steel.

Please note; Finishes are not solid metals and consideration should be given when selection takes place to suitability of product.

**Antique Bronze**



Antique Bronze is a chemically applied finish to Brass profiles to create an aged effect. This is a hand finished process and will vary from batch to batch.

**Antique Brass**



Antique Brass is lighter in shade than Antique Bronze. The chemical is applied then relieved to give a softer effect. This is a hand finished process and will vary from batch to batch.

Please note colours depicted are representative only and are subject to printing interpretations. Please call our sales office for samples.



## BRASS PROFILES WITH SPECIAL FINISHES

50

Profiles shown are available in special finishes shown on page from stock subject to availability.

49



Feline 1



Feline 2

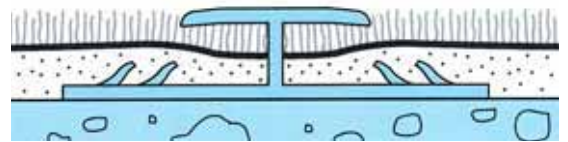

Feline 3

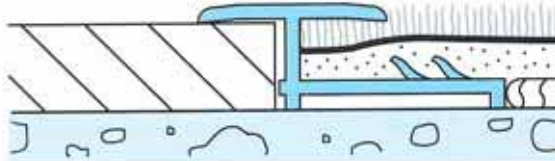

Feline 4



BC38

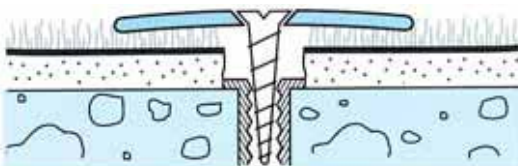

Cover Plates  
Supplied  
centre  
drilled

BC55



BNF

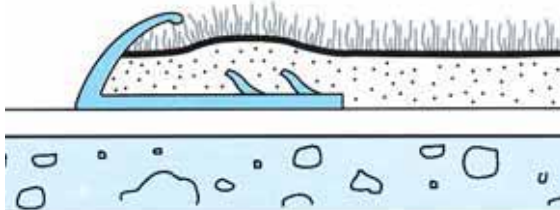

KLIKS Twin profile-KK2 Top



KLIKS available with various bases

BNR



KLIKS Ramp profile-KK3 Top



Feline Edge



### How To Order

Specify profile reference followed by finish required.

Note: profile reference denotes standard brass profile.

### Stock lengths:

Floor Trims: 2.715m x 6 = Packed 16.29m  
 2.715m x 3 = Packed 8.14m  
 0.900m x 6 = Packed 5.40m

Black Chrome 0.900m x 6 only



A select range of C.A.T. aluminium profiles are now produced in chrome finish.

The C.A.T. chrome finish is superior in appearance to electro anodised finishes and provides a cost effective alternative to chrome on brass profiles.

Available in chrome and satin chrome they are ideal for light to medium traffic installations where a high quality finish is required.

C.A.T. Have produced chrome plated profiles for over ten years and take pride in our place as the originators of the concept of special finishes on flooring trims.

### Chrome



When ordering please specify chrome or satin chrome finish required.

### Satin Chrome



#### The Process "How it's made".

The plating of C.A.T. aluminium profiles is carried out in a purpose built facility. Cleaning and degreasing is carried out in an ultrasonic hot soak bath, removing the need to use solvents which can be harmful to the environment.

The plating process is carried out via overhead transporters and each plating tank is surrounded with local exhaust ventilators to prevent harmful mists and fumes escaping.

Once plated all profiles are quality inspected before packing and supply to the customer.



**For a great finish call C.A.T.**



**Feline™ Design © 1993**

Joining profile for carpet

Feline A/9/2

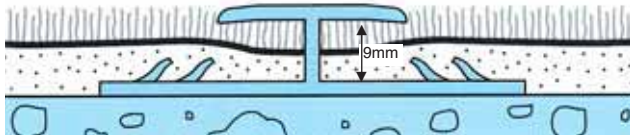

Joining profile for carpet to timber and ceramics

Feline A/10



Trim heights can be adjusted with suitable packers

Feline A/13

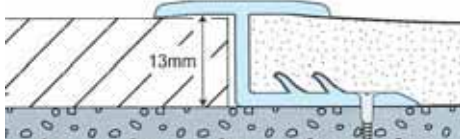

T sections for ceramic tiles

Feline A/T

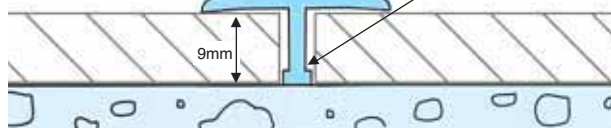

Trims for carpets to resilient and ceramic floors

ANF



CAP IT Punched



**How To Order**

Specify profile reference followed by finish required. • Chrome • Satin Chrome

**Stock lengths:** 0.900m

Packed: 0.900m x 6 = Packed 5.40m



For timber, ceramic, carpet, laminates

KK141 Chrome **End stop**

KK151 Satin Chrome

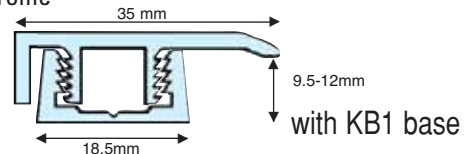

KK142 Chrome **Twin profile**

KK152 Satin Chrome

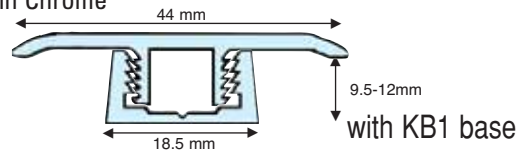

KK143 Chrome **Ramp profile**

KK153 Satin Chrome

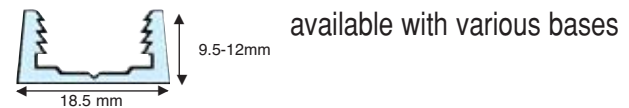
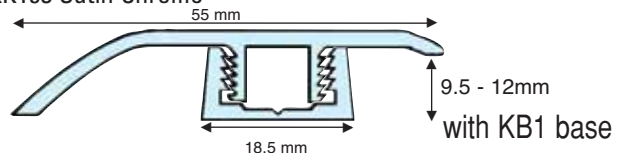

KB1 uPVC Base

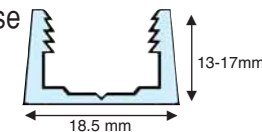

KB2 uPVC Base

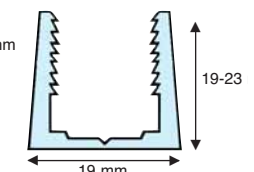

KB3 uPVC Base

**Cover plates**

AC38

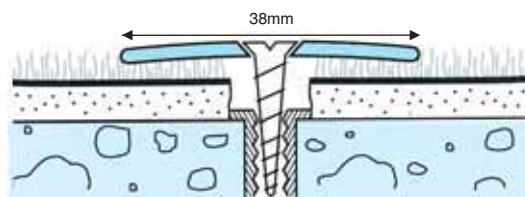

**Supplied centre drilled**

AC55

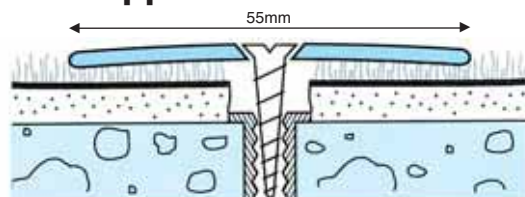

**CAT Gives you choice****Stainless Steel Finishes****Stainless Steel Bright****Stainless Steel Brushed****Aluminium Finishes****Polished Aluminium****Satin Aluminium****Matt Silver Aluminium****Mill Aluminium**

Please refer to relevant product page for availability of finish on profile required.

Please note colours depicted are representative only and are subject to printing interpretations. Please call our sales office for samples.



Product shown is Titan AR65/2 with black insert from a wooden floor to ceramic tiles

**Innovators in Trim Design**



**Technical Information on Curved Profiles**



A successful product installation is largely reliant upon the accuracy of information and 'if required' the quality of template supplied.

When placing an order for curved profiles it is important to provide information for all aspects of the work including floor coverings being laid and the condition of the sub floor to which profiles will be fitted. If there are two different floor coverings adjoining it should be pointed out whether they are level or there is a height difference.

Profiles are formed using traditional fabrication processes and computer aided equipment. This mix of knowledge and technology means we can offer an unparalleled service for specialist trims to the flooring trade.

It is important to note 'the more level the sub floor and adjoining floorings the better the result will be'.

It is possible to form ramp trims, however profiles of a flatter design lend themselves better to fabrication.

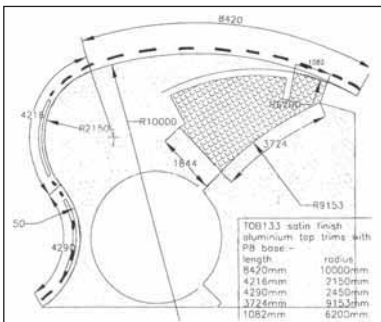

**How to Order**

For profiles with a specified radius it is possible to produce curves from plans once linear meterage is confirmed by the customer, to a maximum radius of 10 metres, over this dimension templates are required.

For curves not of a specific radius hardboard templates should be accompanied by a sketch indicating how trims will be fitted.



Please allow 25% for material wastage in the curving press. Curves are supplied oversize for trimming onsite.

**We are here to help**

For technical advice on the availability and suitability of profiles for curving please call, fax or email your enquiry to our sales office.

To place an order please supply an official purchase order with templates and plans, a contact name and telephone number. The delivery date required and



other information relevant to the project.

Our Fabrication service includes the shaping of stair nosings, stair rods, floor trims and edgings, manufacture and welding of matwells including shaped frames, the folding and forming of bespoke profiles in aluminium, brass and stainless steel.

*If we don't say yes we will say "we will try it"!*



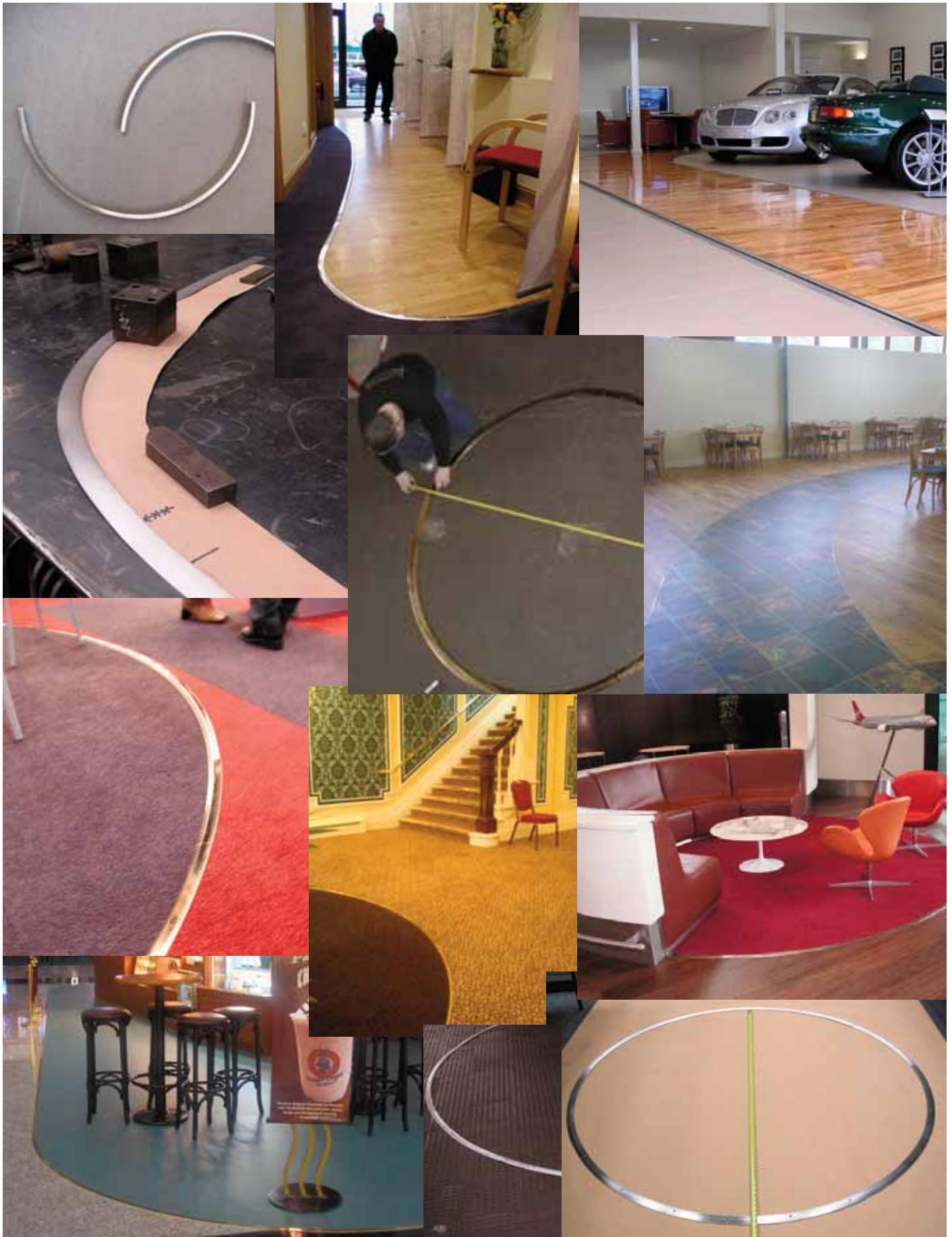



**Vertex** is corner protection from CAT.

Produced from stainless steel and aluminium. Vertex protects corners from knocks, bumps, trolleys, cases etc.

Available in a variety of sizes for all types of wall construction.

## Symbols

- A – Aluminium
- S – Stainless Steel

## Internal Corners

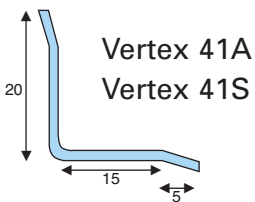
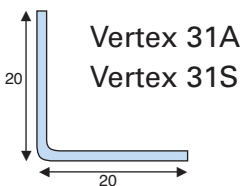

### Stainless Steel

Formed in 1.2mm gauge

### Aluminium

Formed in 1.5mm gauge

### Stock lengths:

2.5m x 6 = Packed 15m

## Finishes

Refer to special finishes page for more information

- Stainless Steel**
- Bright
  - Brushed to order

- Aluminium**
- Mill Aluminium

- Powder coat to special order dependent upon quantity

## External Corners

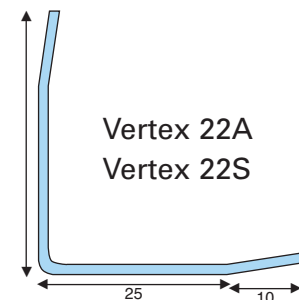
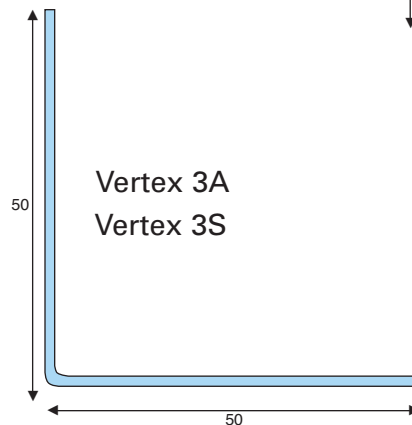
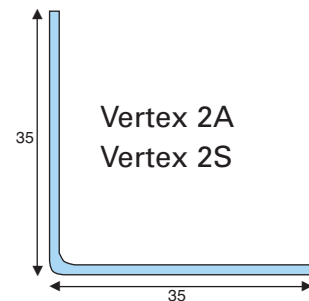
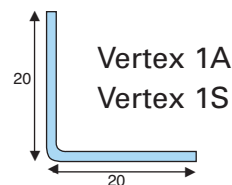

**OTHER SIZES AVAILABLE SUBJECT TO MINIMUM QUANTITY 50 MTRS**

**Supplied undrilled for adhesive fixing.  
Drilled to special order**

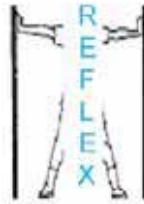
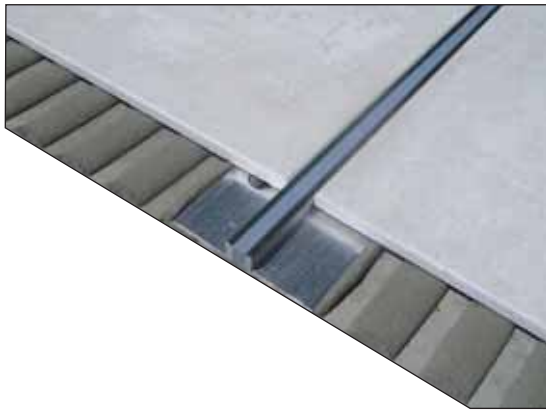

### Expansion Profiles

Reflex profiles are a range of expansion and movement joints, which are designed for use with all hard flooring, eliminating cracking and protecting edges against erosion.

Reflex is acid and alkali resistant and also stain proof. Under pressure, the TPE (Thermo Plastic Elastomer) will compress readily by 20%.

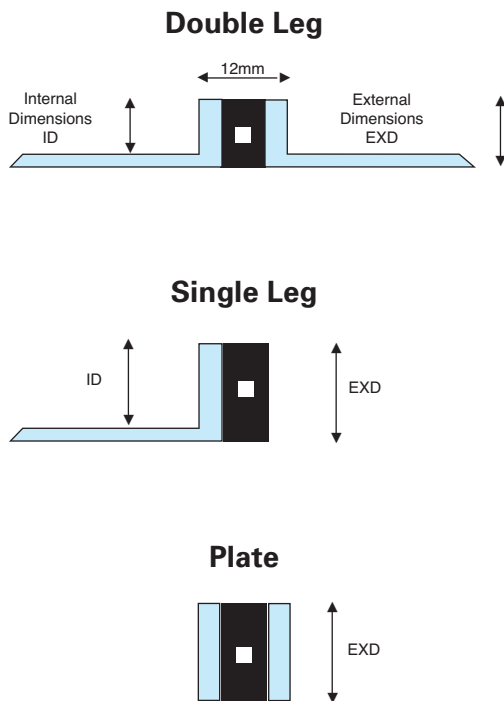

Dimensions		Aluminium	Brass	Stainless Steel
Internal	External			
7.5mm	9mm	RAD9	RBD9	RSD9
11.5mm	13mm	RAD13	RBD13	RSD13
14.5mm	16mm	RAD16	RBD16	
17.5mm	19mm	RAD19	RBD19	
7.5mm	9mm	RAS9	RBS9	RSS9
11.5mm	13mm	RAS13	RBS13	RSS13
14.5mm	16mm	RAS16	RBS16	
17.5mm	19mm	RAS19	RBS19	
	13mm	RAP13	RBP13	

Aluminium Mill  
 Brass Mill  
 Stainless Steel Bright

### Stock lengths:

Aluminium and Brass  
 2.715m x 6 = 16.29m Packed

Stainless Steel  
 2.0m x 6 = 12m Packed

### Stock Colours

Grey      Black

Other colours available  
 subject to minimum requirements



## Reflex Expansion Profiles

CAT strongly recommend that Reflex movement joints should be installed to comply with BS5385-3 and BS5385-5 guidelines for the design and installation of Ceramic, Natural Stone and Mosaic.

The most likely cause of the failure of a ceramic, natural stone or mosaic floor finish is the lack of correct expansion allowance made.

Expansion profiles are fitted to relieve lateral stresses, which can build up due to thermal and structural differences in movement between subfloors, tiles and their surrounds.

### Installation

As a guide they should be installed directly over all structural movement joints, allowing a continuous break through to construction joints in the substrate.

Large surface areas should have expansion trims fitted every 8 to 10 metres and it should be ensured that no area greater than 40 - 50 square metres is unbroken by expansion / movement joints.

The perimeter of the floor should have expansion / movement joints fitted, including around any restraining feature such as columns and in doorways. (Smaller areas may not require this unless unusual stresses are expected.)

Expansion / movement joints should be installed where the tiled surface goes over different subfloor types, i.e. screed to timber or on suspended floors where the tiles go over the tops of walls and RSJ's giving significant differences in flexibility.

### Maintenance

For general cleaning we recommend a diluted mild detergent, and warm water but must be dried immediately after cleaning. The use of steam cleaners or pressure washers is not recommended. For cleaning instruction on the metal components please contact our sales office 01582 561500.

### Technical Properties

The Reflex expansion profiles are made using a 6mm wide TPE (Thermo Plastic Elastomer) flexible insert, bonded onto punched, Aluminium, Brass or Stainless Steel angles, for bedding into adhesive.

Our standard insert width is 6mm; suitable for most installations, for exceptional applications we have other sizes available to special order 10mm and 14mm wide.

The TPE polymer is tested to -30°C where it offers significant low temperature performance advantages over solid flexible PVC material.

For installations where particular fire and fungal growth resistance are requirements, please contact our sales office for assistance.



CAT Instep Discs are an attractive alternative to traditional stair nosings or for highlighting junctions between floor coverings.

Available in aluminium or brass in a variety of finishes.

Simple to install. Drill a recess 25mm dia hole to the correct depth and bond to the step by means of gap filling adhesive.

For further information on installation please contact our technical department.

**Finishes available:**

-  Aluminium Silver
-  Brass
-  Antique Brass
-  Antique Bronze

25 discs per pack (not sold individually)

When installing we recommend the following dimensions

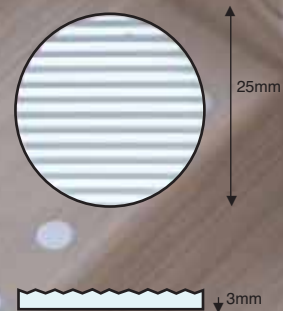

CAT Instep Discs installed on a step edge must have ribs running inline with tread



Tread Edge



STAIR NOSINGS





## Description

CAT nosings are manufactured to the highest quality specification in brass, aluminium and now available in special finishes

A selection of nosings have serrated tread details and others with PVC inserts in a variety of colours.

## Selection

Choose from nosings in various thicknesses and shapes to accommodate different step edges and floor finishes.

Certain nosings are designed with a diminished edge for installation with hard floorings including vinyl, terrazzo, wood, etc.

## Installation

It is highly advisable when fitting stair nosings to use screw fixings and a suitable cartridge adhesive, after ensuring that treads and risers are in good order.

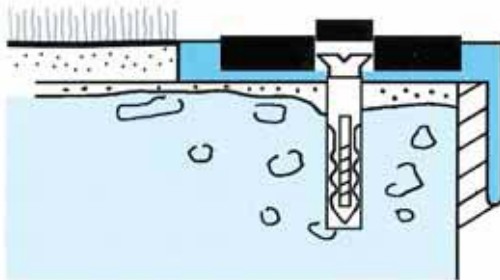

Nosings with PVC inserts can be supplied pre-filled with plugs to conceal screw-heads

Alternatively you can specify CAT **Retrofit** system which eliminates the need for plugs

Refer to page 58 for more information regarding infill colours



A drop of adhesive is required to secure plugs in place.

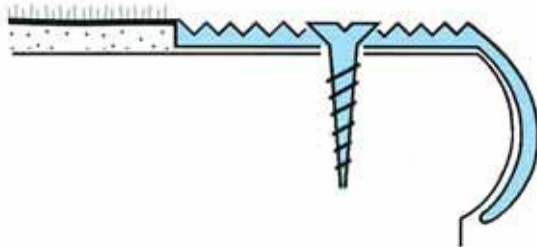

Nosings with ribbed brass treads can be supplied with smooth plugs to conceal screwheads.

Alternatively nosings can be supplied drilled flush for brass screws.

Ribbed aluminium treads are supplied

undrilled or can be supplied for screw fixing if required.

To raise the height of nosings to accommodate thicker floor coverings suitable packing strips of correct gauge can be used, ensuring a good bond is maintained with suitable cartridge adhesive and mechanical fixings.

**NEVER FIT NOSINGS OVER EXISTING FLOOR COVERINGS  
UNLESS SECTIONS ARE DESIGNED FOR THIS SITUATION.**



### Data

Brass alloy to BS 2874 : 1986.  
 Aluminium alloy to BS 1474 : 1987.  
 PVC to BS 6746 : 1990.

### Special Finishes on Brass Nosings

Available on stock lengths only -  
 please call sales office for availability



BN1 Antique Bronze

***For further advice on the maintenance of a particular product please contact our sales office.***

### Measuring

Steps should be measured and numbered from the top of the staircase to the bottom, indicating flights and landings for the cutting and installation plan.

For curved steps please refer to stair nosing fabrication section for advice on templating **on page 74**

### Supply

Stair nosings can be cut to customers sizes or supplied oversize (by 30mm) if specified, for cutting on site.

### Maintenance

**Brass** nosings are produced with a highly polished finish, regular cleaning with a suitable metal polish and soft cloth is advised to maintain their finish, alternatively nosings can be left to age oxidize for a natural finish.

Avoid water and all forms of moisture with brass nosings.

**Aluminium** ribbed tread sections which are polished aluminium can be maintained with a metal polish. Anodised and satin nosings should be cleaned with a mild detergent and warm water but must be totally dried immediately after cleaning.

**PVC inserts** should be cleaned with a mild detergent diluted with water on a damp - not wet - cloth, ensuring that inserts are wiped dry before staircase is open to traffic.

**POLISHES AND INDUSTRIAL CLEANING AGENTS SHOULD NOT BE USED ON TREADS AND INSERTS AND MAY PROVE HAZARDOUS IF USED.**



### Brass Stair Nosings with PVC insert



Special finishes to order.  
 Antique Bronze • Antique Brass •  
 Chrome • Satin Chrome • Nisheen

### Polished Brass Stair Nosings with ribbed treads



Special finishes to order.  
 Antique Bronze • Antique Brass

### Aluminium Stair Nosings with PVC insert



Mill • Polished • Satin

### Aluminium Stair Nosings with ribbed treads

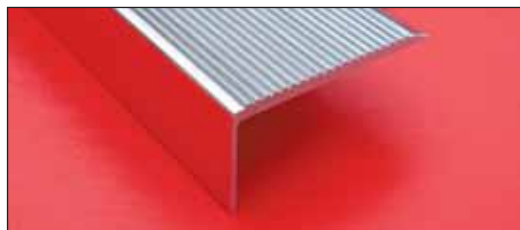

Mill • Polished • Satin • Matt Silver Anodised

### Aluminium Stair Nosing AN6 • AN7 with castellated treads



Mill • Polished • Satin • Matt Silver Anodised

### Aluminium Stair Nosing AN3 • AN4 • AN5 with castellated treads



Mill • Polished • Satin

### Stainless Steel Cover Nosings with PVC inserts



Bright • Brushed



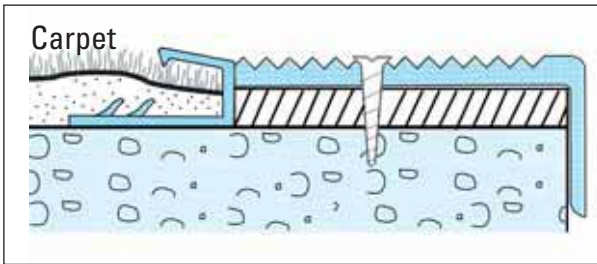

BN1 Brass nosing installed on a packer to raise height equal to top of feline edge.

Carpet then installed into feline edge.

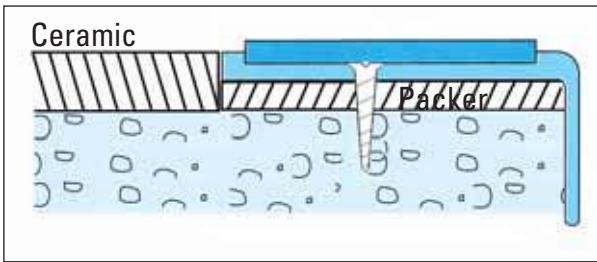

BN5 Brass nosing installed on packer to raise to same height equal to top of ceramic tile.

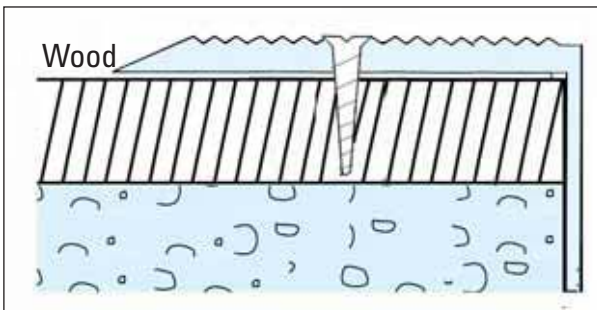

AN1 Aluminium nosing directly installed on to wood to create safe edge.

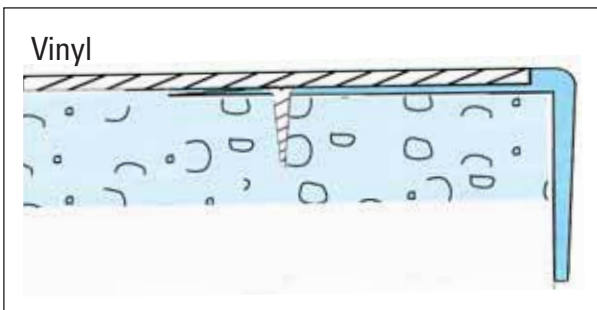

BN20 Brass nosing installed to create neat edging for vinyl.

Use of featheredge required to take away thickness of BN20 base.

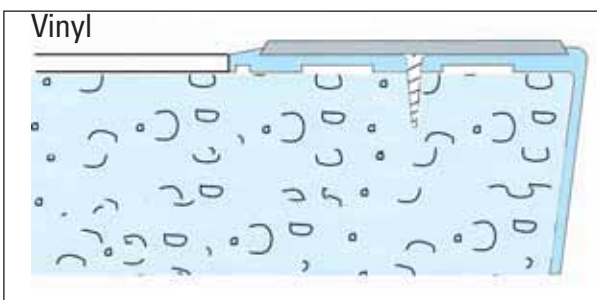

BN17 Brass nosing installed directly to step edge.

Vinyl is then laid up to the nosing.

**These are suggestions only and consideration needs to be taken into account of floor coverings being used and that all step edges have been made good and flat.**

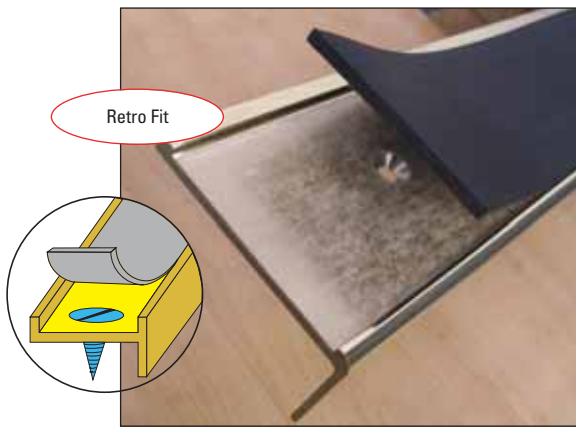

**Retro fit-** For a neat, concealed fixing finish specify Retro-fit when selecting CAT stair nosings with PVC infills

**Installation instructions:**

**Retro Fit:** Nosings are supplied cut to size, pre-drilled for countersunk screw fixings. On site having secured nosings to tread with screws and cartridge adhesive, peel away protective cover from adhesive carrier tape.

Insert infill into carrier applying pressure ideally with a roller to ensure a good bond along the entire width of tread.

**Please note:**

Infills are supplied 50mm oversize for trimming in. Having trimmed infill ensure bond is good at each end of nosing.

Infills should be fitted at normal room temperature, not in cold environments to avoid the possibility of any contraction.

**Infill plugs-** The alternative method of fixing infilled nosings to stairs.

**Installation instructions:**

**Infill plugs:** Nosings are supplied pre-drilled and affixed with screws and cartridge adhesive to treads. Having fixed screws a dab of adhesive is applied with a match (or something similar) to heads and plugs gently tapped home.



**Textured Colours**

BLACK	WHITE	LIGHT GREY	FLINT	GRANITE	REGENCY	MID BLUE	NIMBUS	PEAT
RUSTIC	FAWN	IVORY	SPRUCE	JADE	YELLOW	POPPY	CLARET	PORTH STONE

NB. Please note colours depicted are representative only and are subject to printing interpretations.

For a sample please contact our sales office.

**Cleaning**

Infills should be cleaned with a mild detergent, diluted with water on a damp, not wet, cloth ensuring that infills are completely dry before staircase is open to foot traffic.

Avoid contact with stair nosing carrier.

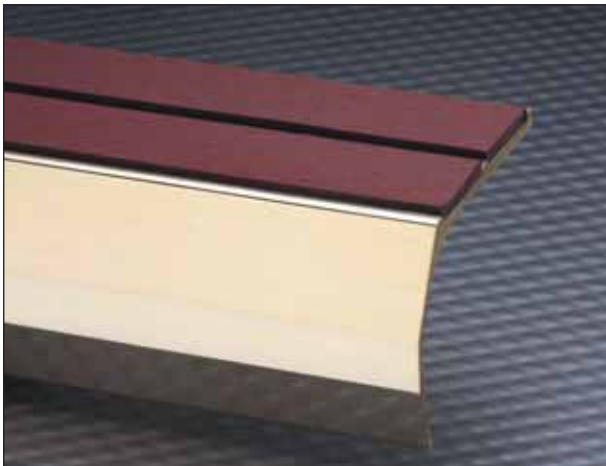

Stair nosings with PVC inserts are supplied with concealing plugs for hidden fixings.

Can be undrilled if preferred.

Alternatively nosings can be drilled through carrier only and inserts fitted after fixing to stairs for a plug free finish using CAT's Retrofit system

Please see Technical Information - Installation.

**Special finishes to order • Stair Nosings**

Refer to special finishes page for more information

**Stair nosings can be supplied cut to size or in stock lengths at customer's request.**

**Stock lengths: 3.5m**

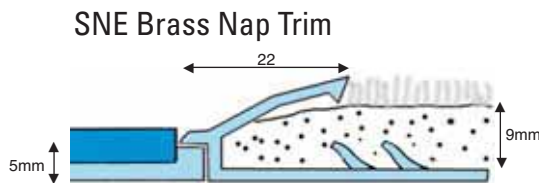

requires dressing down  
Used to trap edge and protect  
carpet installed behind  
nosing.

**Special Finishes • SNE**

- Antique Brass
- Antique Bronze

Available in polished brass.

**5MM GAUGE NOSINGS**

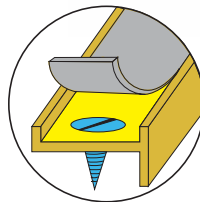
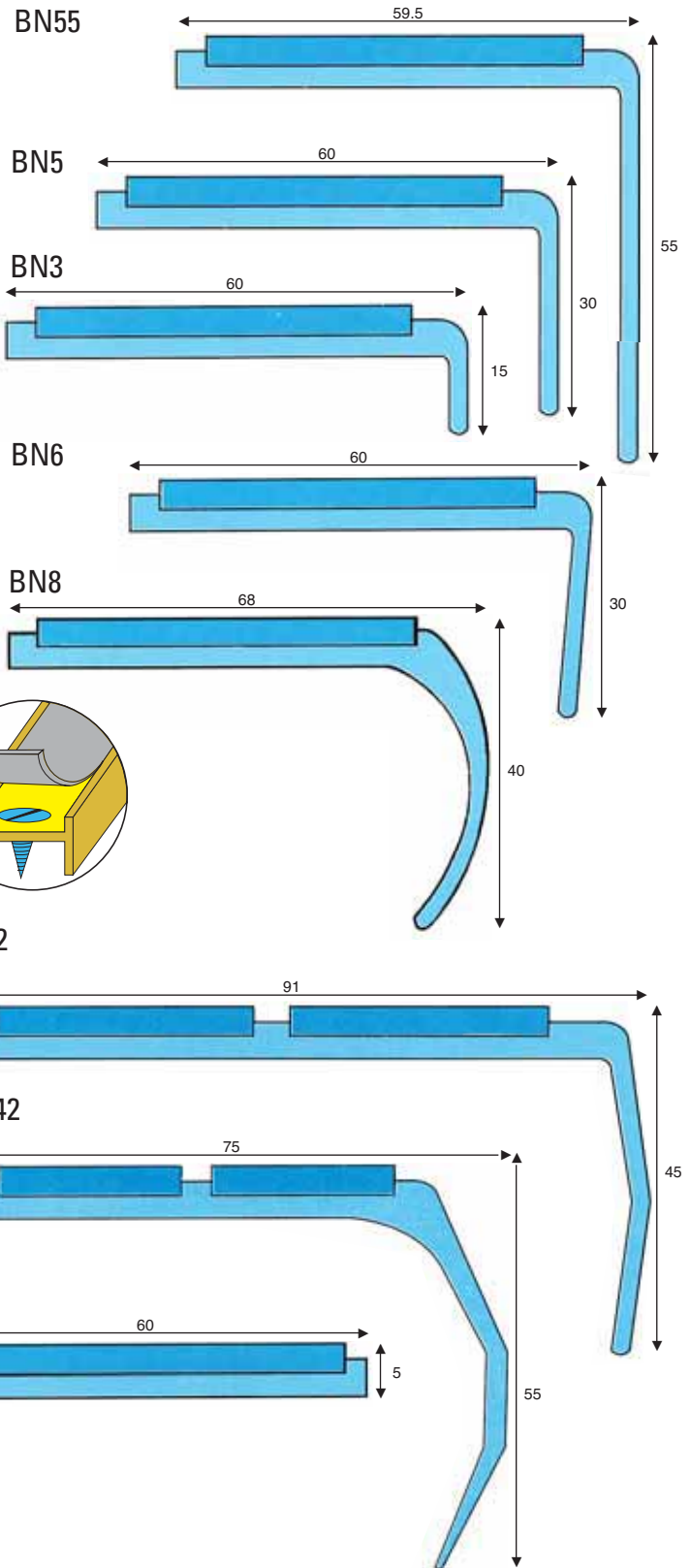

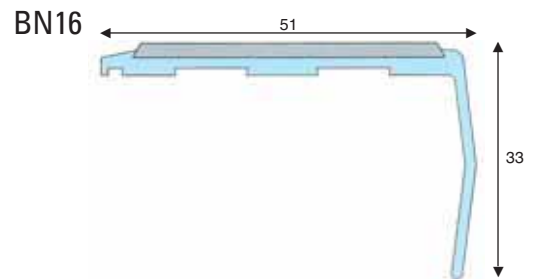
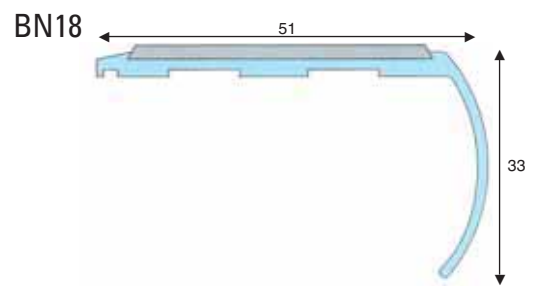
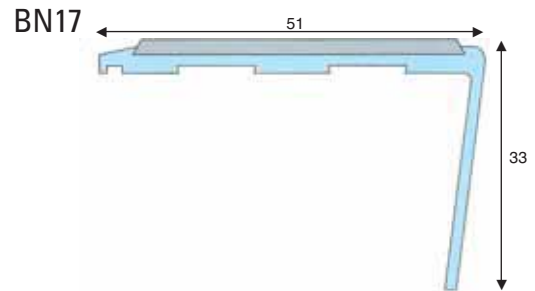
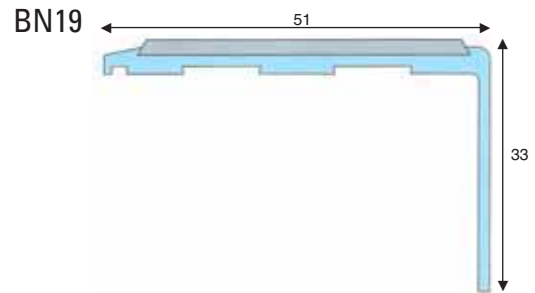
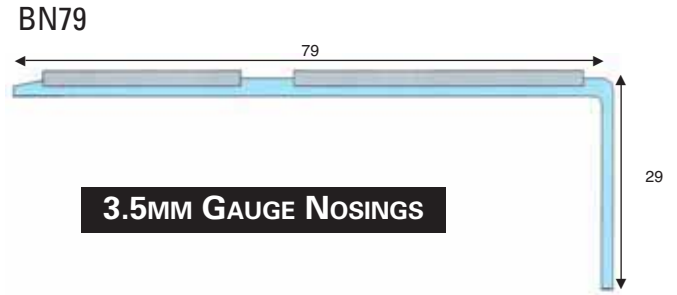

Stair nosings with PVC inserts are supplied with concealing plugs for hidden fixings.

Can be undrilled if preferred.

Alternatively nosings can be drilled through carrier only and inserts fitted after fixing to stairs for a plug free finish using CAT's retrofit system

Please see Technical Information - Installation.

**Special finishes to order • Stair Nosings**

Refer to special finishes page for more information

**Stair nosings can be supplied cut to size or in stock lengths at customer's request.**

**Stock lengths:**

3.5m



Stair nosings with PVC inserts are supplied with concealing plugs for hidden fixings.

Can be undrilled if preferred.

Alternatively nosings can be drilled through carrier only and inserts fitted after fixing to stairs for a plug free finish using CAT's Retrofit system.

Please see Technical Information - Installation.

**Special finishes to order • Stair Nosings**  
Refer to Special Finishes page for more information

**Stair nosings can be supplied cut to size or in stock lengths at customer's request.**

**Stock lengths: 3.5m**

### Nosings with feathered edges

#### 3.5MM GAUGE NOSINGS

BN15 Brass  
AN15 Aluminium

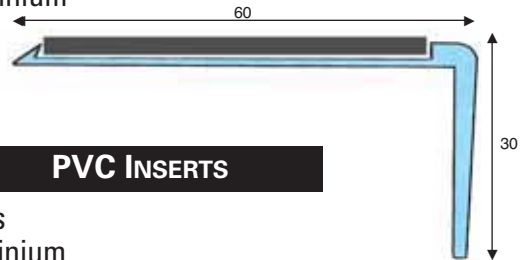

#### PVC INSERTS

BN14 Brass  
AN14 Aluminium

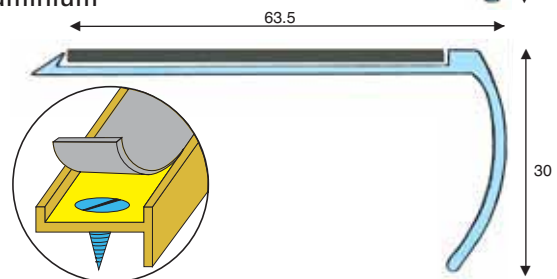

### Nosings for resilient floorings

BN20 Brass  
AN20 Aluminium

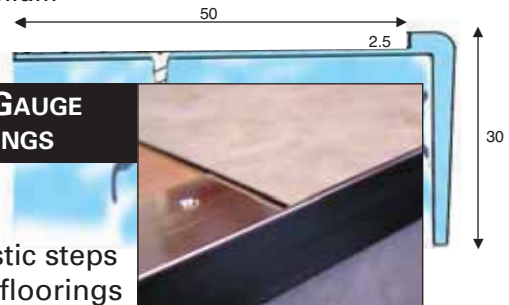

#### 1.5MM GAUGE NOSINGS

BN20/15 Brass  
AN20/15 Aluminium

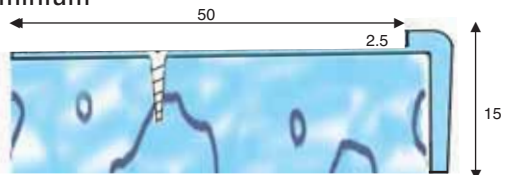

BN21 Brass  
AN21 Aluminium

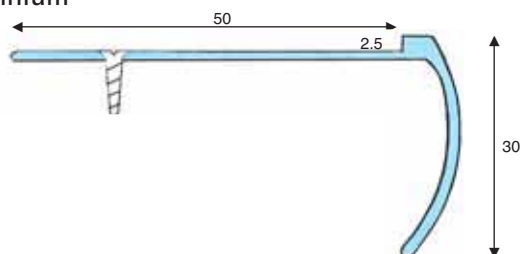



CAT Design © 2007

## Stainless Steel Nosing with infill

Stainless Steel cover nosing with PVC insert.



Stair nosings with PVC inserts are supplied with concealing plugs for hidden fixings.

Can be supplied undrilled if preferred.

Alternatively nosings can be drilled through carrier only and inserts fitted after fixing to stairs for a plug free finish using CAT's retrofit system

Please see Technical Information - Installation.

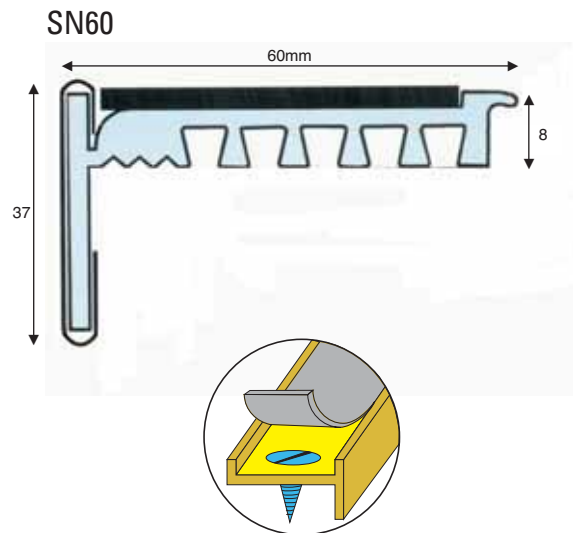

Stair nosings can be supplied cut to size or in stock lengths at customer's request.

**Stock lengths:**  
2m

### Finishes available

- Bright Stainless Steel
- Brushed Stainless Steel

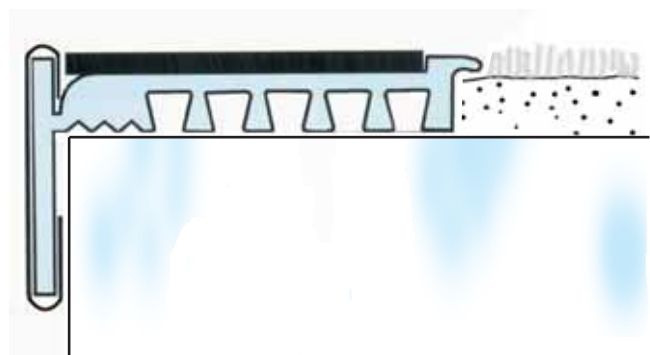

Manufactured to special order, please allow 14 working days



## Polished Brass with Ribbed Treads

A stylish alternative to Brass nosings with pvc inserts for installations that require additional elements of design.

Suitable for use with many floor coverings including wood, ceramics and carpets.

Stair nosings with ribbed treads can be supplied with either countersunk brass screws or zinc screws and smooth concealing plugs secured with adhesive.

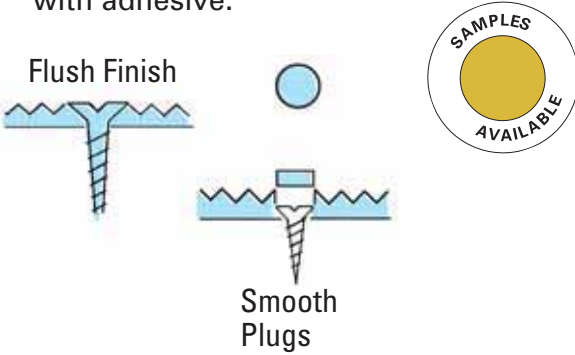

### Special finishes to order

Refer to special finishes pages for more information

- Antique Bronze
- Antique Brass

Stair nosings can be supplied cut to size or in stock lengths at customer's request.

Stock lengths: 3.5m

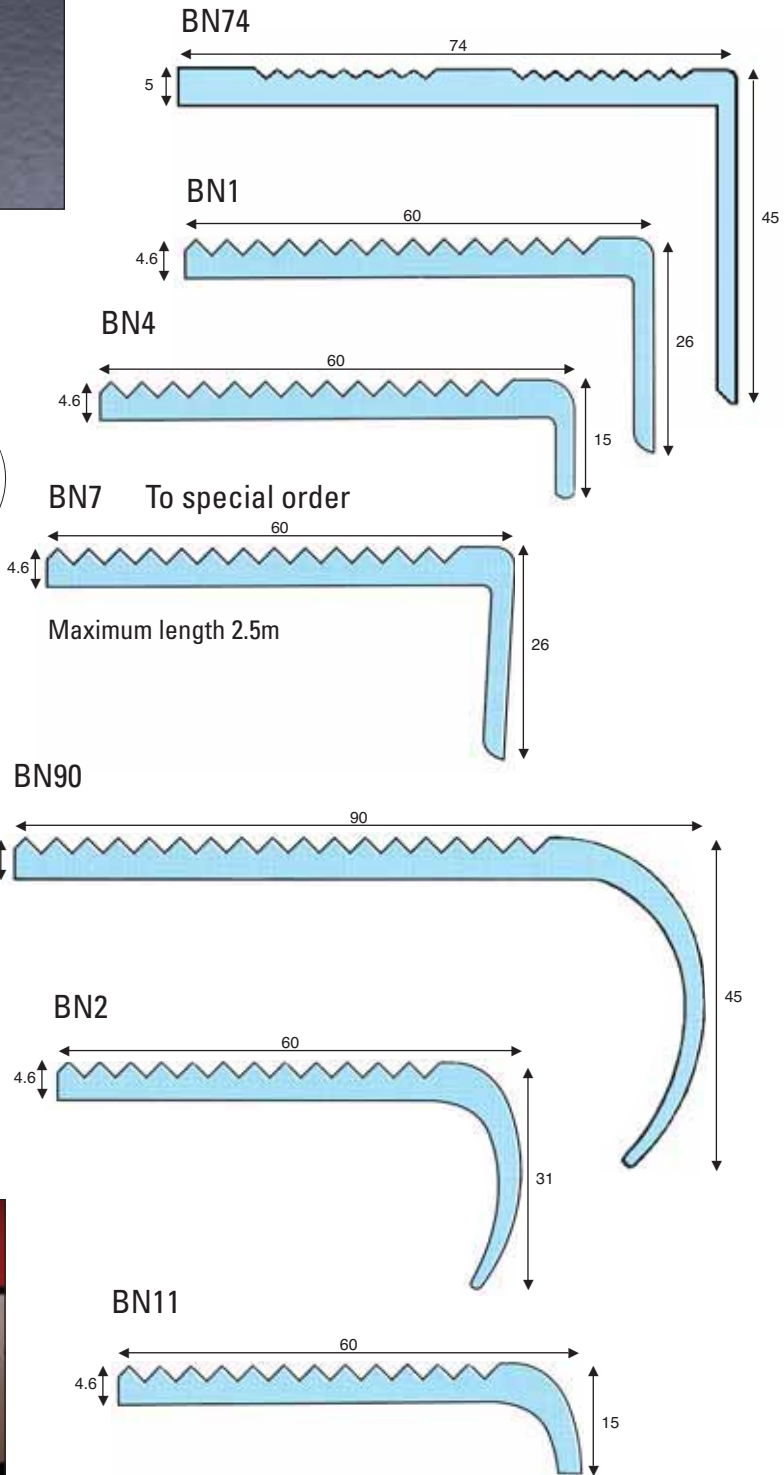

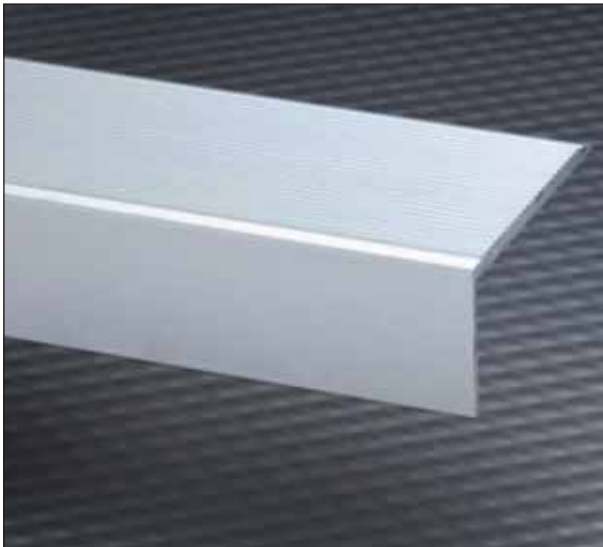

## Aluminium with Ribbed Treads

A popular alternative to aluminium nosings with PVC inserts.

A feathered back edge makes profiles suitable for fixing directly to wood and ceramics.

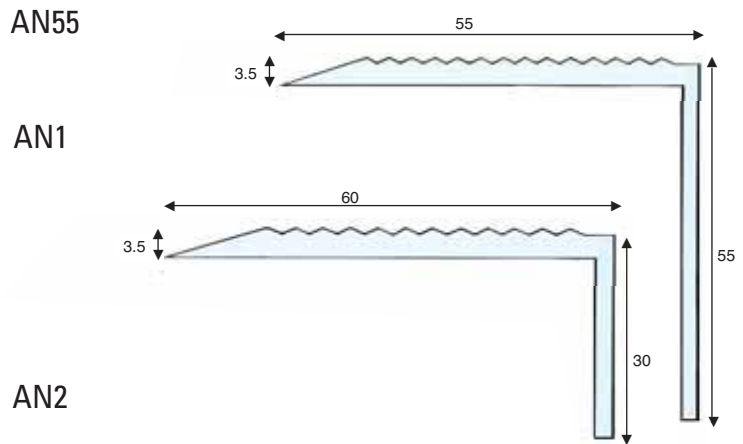

- Mill Aluminium
- Polished Aluminium
- Satin Aluminium
- Silver Anodised ● Matt Silver

Refer to special finishes page for more information

Stair nosings can be supplied cut to size or in stock lengths at customer's request.

Stock lengths 3.5m

## Aluminium with infill

AN60



- Mill Aluminium
- Polished Aluminium
- Satin Aluminium

For infill colour choice please refer to page 66  
For drilling options please refer to page 66



## Edgings

Ideal for finishing edges of flooring

AE32/S

Stainless Steel Cover

- Bright
- Brushed

Made to special order only.

Stock length: 2.0m  
Packed: 6 x 2.0m

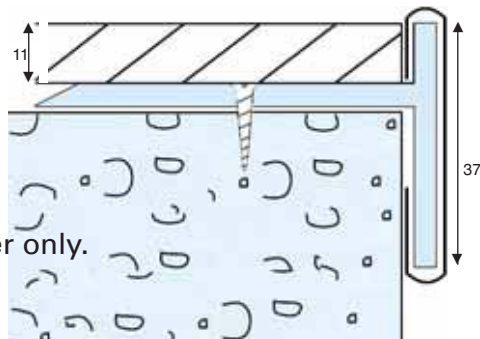

AE32

- Mill Aluminium
- Satin Aluminium
- Polished Aluminium

Stock length: 2.715m  
Packed: 6 x 2.715m

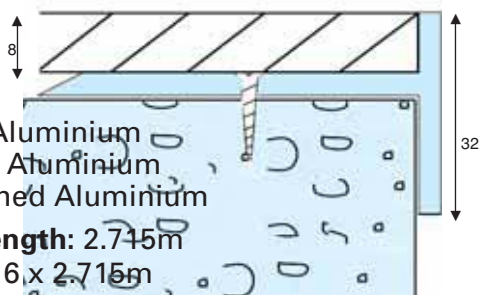

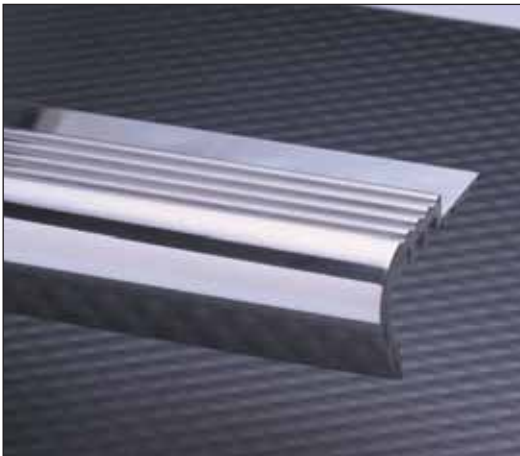

## Aluminium with Castellated Treads

A popular alternative to aluminium nosings with PVC inserts.

Stair nosings can be supplied cut to size or in stock lengths at customer's request.

Stock lengths: 3.5m

Available drilled or undrilled.

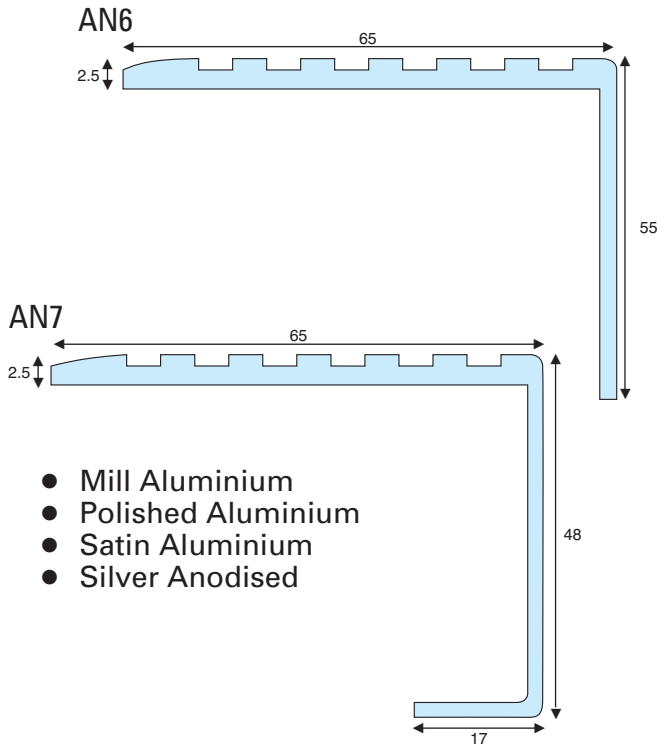

- Mill Aluminium
- Polished Aluminium
- Satin Aluminium

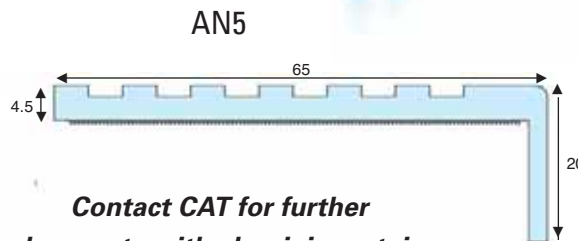
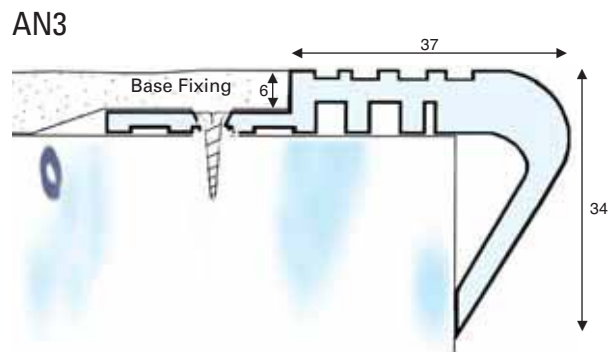
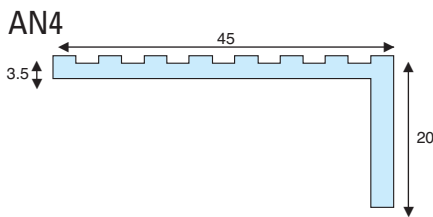

Contact CAT for further developments with aluminium stair nosings and edgings.



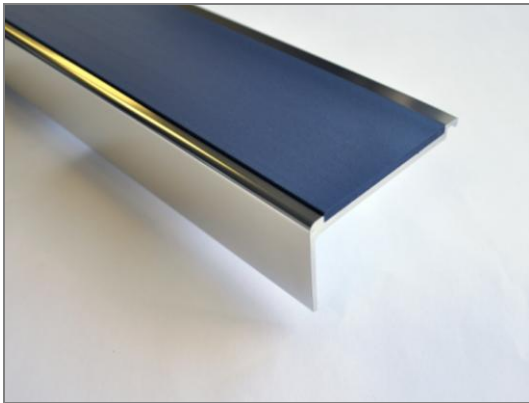
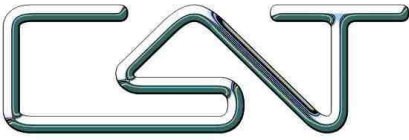

## Aluminium Stair Nosings with PVC Infills

5mm gauge

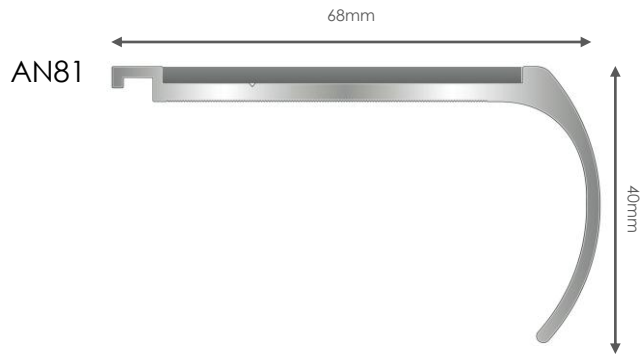
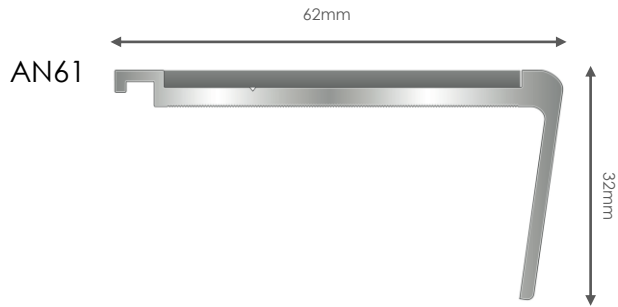
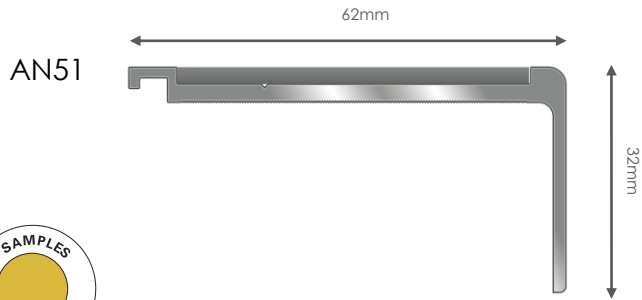

### Installation Methods

- Pre Drilled with concealing plugs supplied for hidden fixing
- Aluminium carrier pre drilled and infill retro fixed after nosing installation to tread
- Undrilled

Always use a suitable adhesive in conjunction with screw fixings

### Finishes Available

Mill Aluminium  
Satin Aluminium  
Polished Aluminium

### Cut Sizes

Stair nosings are available in sizes to a maximum length of 3.2 metres

For further information, technical advice or samples, please contact CAT sales.

### Data

Aluminium alloy to BS EN755 part 1.2 and 9 : 2008

PVC to BS 6746 : 1990

### Infill Colours Available

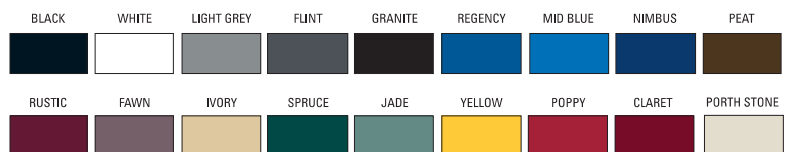

Please note colours depicted are representative only and are subject to printing interpretations.



## Description

A fabrication service is available for the curving and shaping of a selection of nosings subject to step shape.

Also available are mitred and welded returns and capped ends for a neat finish to the end of nosings on open string staircases (see page 67).

When ordering curved nosings a hardboard or stiff card template is required to work from for each curved step.

## Instructions

### How to Take a Template

Step edge should be free from existing floor covering.

Where required step edge should be made good with repairs before template is taken.

Offer card on top of stair tread and with a marker pen draw around curve on underside of card at stair edge.

Ensuring that line is uniform cut along mark, then offer shaped card to step and make any adjustments as required.

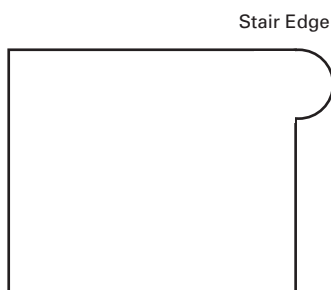
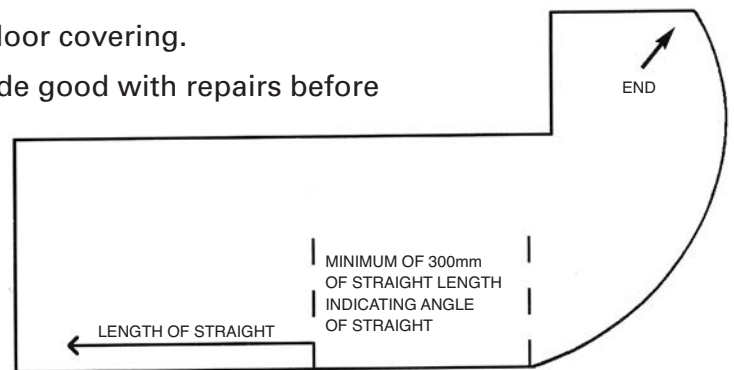

### Please indicate on all templates

- Nosing profile.
- Customer name and job reference.
- Order number.
- Top side of template.
- Edge of tread.
- Infill colour if PVC insert.
- Special drilling instructions.
- Allowance (if any) for new floor covering.
- When job is required.

**All curved nosings are supplied oversize for trimming on site.  
The maximum length of a curved nosing in one piece is 3.2 metres.**

**It is important to contact our sales office for the suitability of sections for curving.**

**Curves and mitres of chrome nosings are subject to availability.**

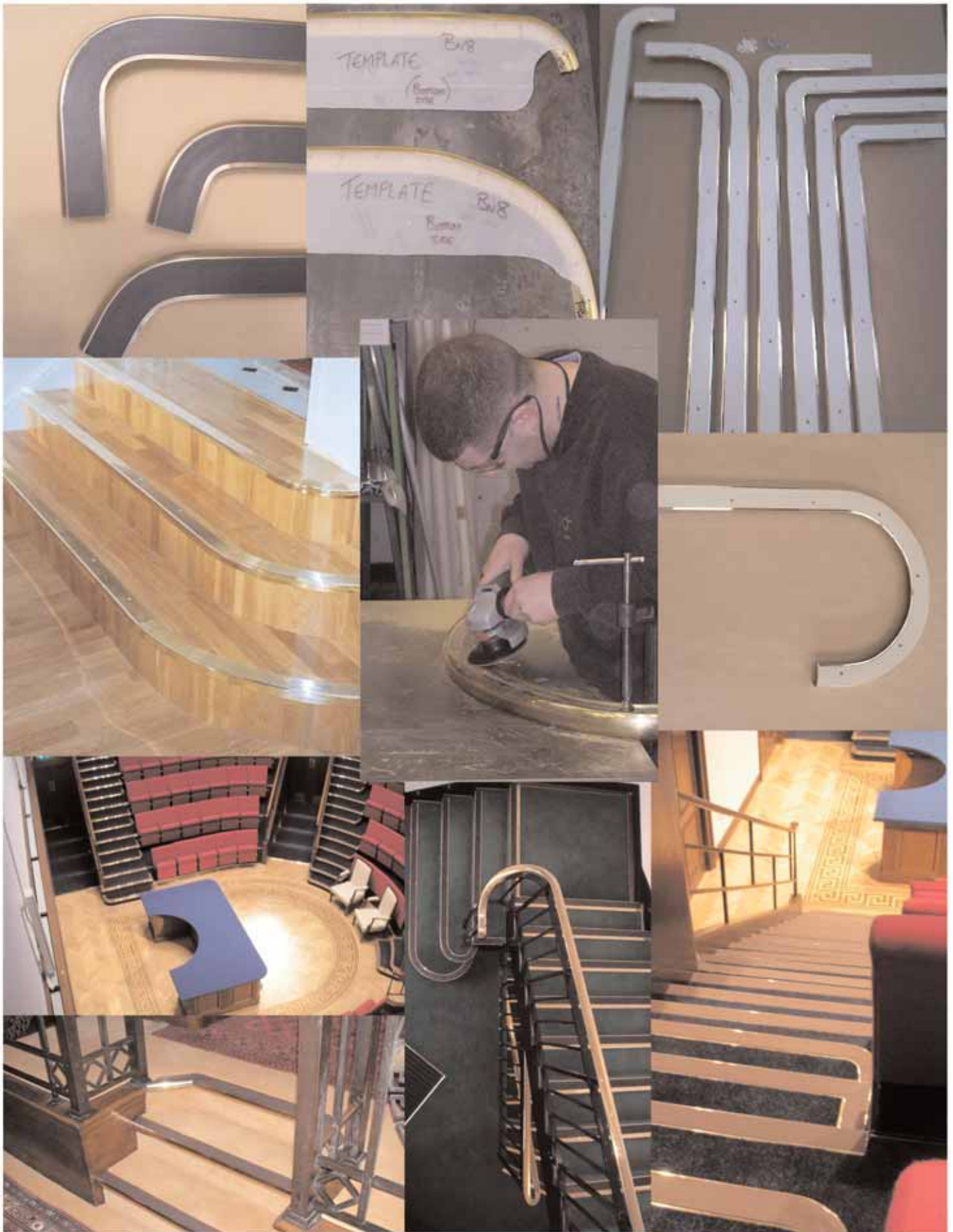



### Brass Welded Stringer Trim

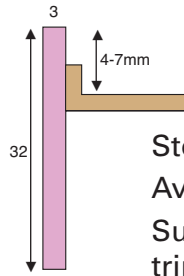

Stock angles 83° and 90°  
 Available 81° and 90°  
 Supplied oversize for trimming on site.

Polished brass angles for use with CAT stair nosings as a masking detail for external strings.

Stringer sizes: 360mm x 360mm  
 stringer stock lengths: 1.83mtr

### Brass Stair nosing with Stringer Trim

Stair nosings can be supplied with welded stringer trims to mask string details where floorings are installed on tread only and riser is left bare or there are no risers.

Please specify left or right handing when ordering.

### Brass Welded Mitre

Stair nosings can be supplied with 90° welded mitres.

When ordering please specify left or right handing, and length of return.

### Brass Welded Capped End

Stair nosings can be produced with welded capped ends.

When ordering please specify left or right handing.

### Installation

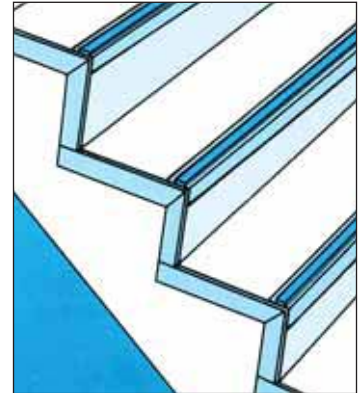

When trimmed apply adhesive to inside face of angle and hold till set.



Mitres and fabricated nosings are available in chrome subject to approval.

Contact the sales office for more information.

10





## Tips For Measuring Stair Rods



You will find a little CAT everywhere.

### Measuring Stair Rods

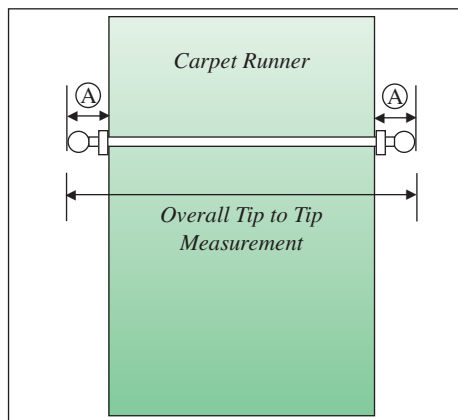

eg. Rods with *turned* finials if carpet runner is 686mm (27")

Ⓐ Add 100mm (50mm each end)  
Overall rod length 786mm tip to tip

eg. Rods with *large* finials if carpet runner is 686mm (27")

Ⓐ Add 150mm (75mm each end)  
Overall rod length 836mm tip to tip

Measurements are always taken as tip to tip

#### **Carpet Runners**

For rods with turned finials, measure the full width of the runner and add a minimum of 100mm for 10, 12.5 and 16mm rods. For 19mm rods and rods with large finials an additional 150mm is desirable having given consideration to available staircase width.

#### **Full Width Carpets**

For rods with turned finials, measure the full width of the stairs and deduct a suitable amount to create best effect.

**CHECK THAT STEP WIDTHS DO NOT VARY DRAMATICALLY.**

Fix eyes into tread risers directly alongside edge of carpet runner, leaving a gap of approximately 1/8" (3mm)). Use rawl plugs for mechanical fixings into concrete stairs and direct screw fix into timber on wooden staircases, except when ring eyes are fitted and rawl plugs are advised to except threaded taper fixing. Always use wooden gripper with stair rods.

When installing top fix eyes for fully fitted carpets exercise caution when fixing through carpet.



[www.cat-accs.com](http://www.cat-accs.com)

Technical Advice



*Solid Brass Stair Rods and Eyes*



*Choice*

*Round Rods with Turned Finials*

Available in 10, 12.5, 16 and 19mm diameter rods.

Ball



Acorn



Castle



Coronet



Minstrel



Oval



Spear



Solar



Beacon



Turret



**Please note:**

Hinged eyes with trefoil fixings only supplied while stocks last. New screw fixing replacement being phased in all sizes.

*Brass Fixing Eyes*

Supplied two hinged or plain eyes per rod.



**Hinged Eye**

Suitable with round rods in 10, 12.5, 16, 19mm diameter. Recommended where removal of rods is required.



**Plain Eye**

Suitable with round rods in 10, 12.5, 16, 19mm diameter. For stairs with open strings and rod removal is not required.

*Special finishes available*

Antique • Nickel • Chrome



*Solid Brass Stair Rods and Eyes*



*Choice*

Choose large finials for **impact** and **effect**.

*Round Rods*

*Large Finials*

**Ball**  
12.5, 16mm



**Acorn**  
12.5, 16mm



**Pineapple**  
12.5, 16mm



**Arrow & Flight**  
12.5, 16mm



**Paris**  
12.5mm



**Manhattan**  
12.5mm

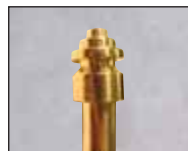

**Jester**  
12.5mm



*Brass Fixing Eyes*

Supplied two hinged or plain eyes per rod.



**Hinged Eye**  
Suitable with round rods in 12.5, 16mm diameter. Recommended where removal of rods is required.



You will find a little CAT everywhere.

*Special finishes available*

Antique • Nickel • Chrome



*Triangular brass stair rods and eyes*



Produced in solid triangular rod  
22mm face highly polished



You will find a little CAT everywhere.

*Choice*

*Large Finials*

Fleur-De-Lys



Trefoil



Spear



*Plain End*

Plain



*Brass Fixing Eyes*



Triangular Hinged Eye  
Suitable with triangular rods for stairs where regular removal is required.

Please note:- Triangular Hinged eyes must always be fitted with triangular rods with finials.  
Supplied two hinged eyes per rod.



Triangular Plain Eye  
Suitable with plain triangular rods for stairs with open strings and rod removal is not required.

Plain eyes are only suitable for use with triangular plain rods.  
Supplied two plain eyes per rod.

*Special finishes available*

Antique • Nickel • Chrome



*New Look! Old Effect!*

Brass stair rods and eyes are available in a variety of special finishes to compliment interior designs. Please check with C.A.T. sales for suitability of finish with rod selection and intended installation.

*Choice*

Chrome and Nickel electroplate finishes on brass for superb contemporary effects.

*Chrome and Nickel*

*Black Chrome.  
Only available 12.5mm  
rods with plain eyes.  
Max. length 1250mm*

Bright  
Chrome



Satin  
Chrome



Bright  
Nickel



Satin  
Nickel



Black  
Chrome



*Antique Finishes*

Antique finishes are applied by hand to brass creating an aged effect. This hand finishing process produces finishes varying in shade from batch to batch.

Antique Bronze



Antique Brass



You will find a little CAT everywhere.

Please note; Finish images are subject to printing interpretation, individual samples available upon request.



## *Hollow Brass Stair Rods and Eyes*



You will find a little CAT everywhere.



### *Finials*



Stair rods are produced in 12mm diameter hollow tube 1 metre in length and are suitable for stairs with carpet runners to 900mm (36") in width.

### *Choice*

Brass



Chrome



Satin Chrome



All rods are supplied with two hinged eyes for each tread.

### *Measuring and Installation*

Measure the full width of carpet runner and add a minimum of 100mm including finials to give finished rod length, subject to maximum available width of staircase. Cut rod to size with a hacksaw, being careful to cut evenly and clean burred edges with emery cloth allowing finials to be inserted.

To increase tightness of finials in tube turn nut on thread to expand rubber bung.

Stair eyes should be fixed directly alongside edge of runner. Use rawl plugs for mechanical fixings into concrete stair and direct screw fix into timber (having drilled pilot hole first) on wooden stair.



*Special Products*

*Stair Rod Fabrication*

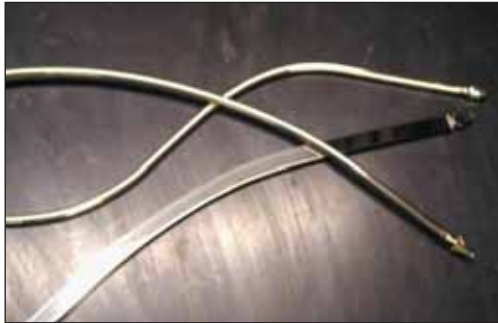

Curved rods can be produced from customer's templates.

*Specialist Fixing Eyes*



**High Style Hinged Eyes**  
Specification as standard hinged eye but with deeper tread and riser detail - 12.5mm, 16mm. Recommended with thick carpets and felt.



**High Style Plain Eyes**  
Specification as standard plain eye but with deeper tread and riser detail - 12.5mm, 16mm. Recommended with thick carpets and felt.

*Joining Detail*



available for 19mm rods over 3000mm in length.



**Top Fix Eye**  
Suitable with round rods- 12.5mm diameter. Use with full width Carpets and turned rods to create a traditional effect.

*Stair Clips*

*Simple in design*

*Stylish in effect*



You will find a little CAT everywhere.



-  Polished Brass
-  Antique Brass
-  Antique Bronze
-  Polished Steel
-  Chrome



## *Stair Rod Maintenance Guide*



### *Brass Stair Rods*

All brass will tarnish with atmosphere.

In order to maintain an acceptable shine on interior brass furnishings, including profiles, we would suggest regular polishing of the brass with a suitable metal polish. Regular polishing is particularly important for brass in a public location, where regular contact with passers-by and even beverages can tarnish the surface of the brass.

We would certainly recommend avoiding use of any water based cleaning agents as this is very likely to accelerate tarnishing and can well lead to staining and corrosion.

It is worth noting that the longer water stains or water based cleaned surface are left unpolished the more difficult stains are to remove.

Lacquers are not recommended and will prevent tarnishing for a limited period only and at which time it may be desirable to strip remaining lacquer and polish brass.

The information given above is based on the present level of our knowledge and experience.



### *Antique Stair Rods*

Wipe with a dry cloth or duster.

Do not use any liquids or polishes on these finishes.



### *Chrome and Nickel Stair Rods*

Buff with a dry cloth or duster.

A damp clean cloth may be used for heavily soiled rods but must be dried immediately

The data given is not intended as confirmation of product properties and does not constitute a legal contractual relationship, nor should it be used as a basis for ordering products.

For customers with old tarnished rods, we are happy to re-polish, once having inspected them and given an assessment of finish achievable.



[www.cat-accs.com](http://www.cat-accs.com)

CI/Sfb	(43)Y+(44)	Hh
--------	------------	----

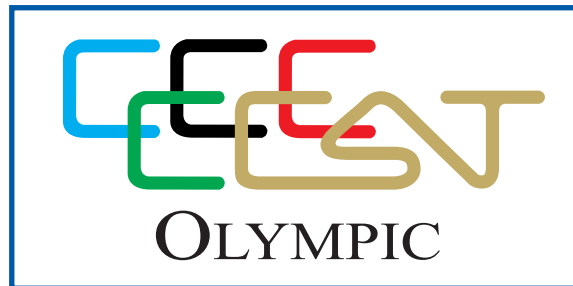

**Heavy Duty Stair Nosings • Treads •  
Insert Discs and Strips •  
Indicator Corduroys and Studs •**



## **The C.A.T. Olympic Range with CarbiGrip**

Specialist products for industrial and commercial installations

**Innovators in Trim Design**



Olympic is a range of products from C.A.T. for interior and exterior applications.

This section of the catalogue contains information on heavy duty stair nosings • insert discs and strips • tactile indicator corduroys and studs.

Stair nosings are infilled with carbigrrip - a composite of various grits, including aluminium oxide set in a cured epoxy, ideal for external steps in heavily trafficked locations.

The Olympic brand is a continually developing range to assist with DDA compliance.

For further information on Olympic nosings and tactile systems please contact C.A.T. sales.



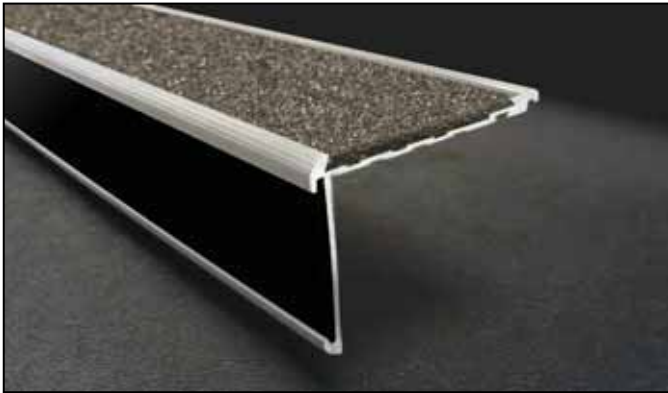

Supplied cut to size • maximum 2.5m length.  
Pre-drilled and countersunk for No. 8 screws.

Tread profiles are 7mm thick (aluminium).

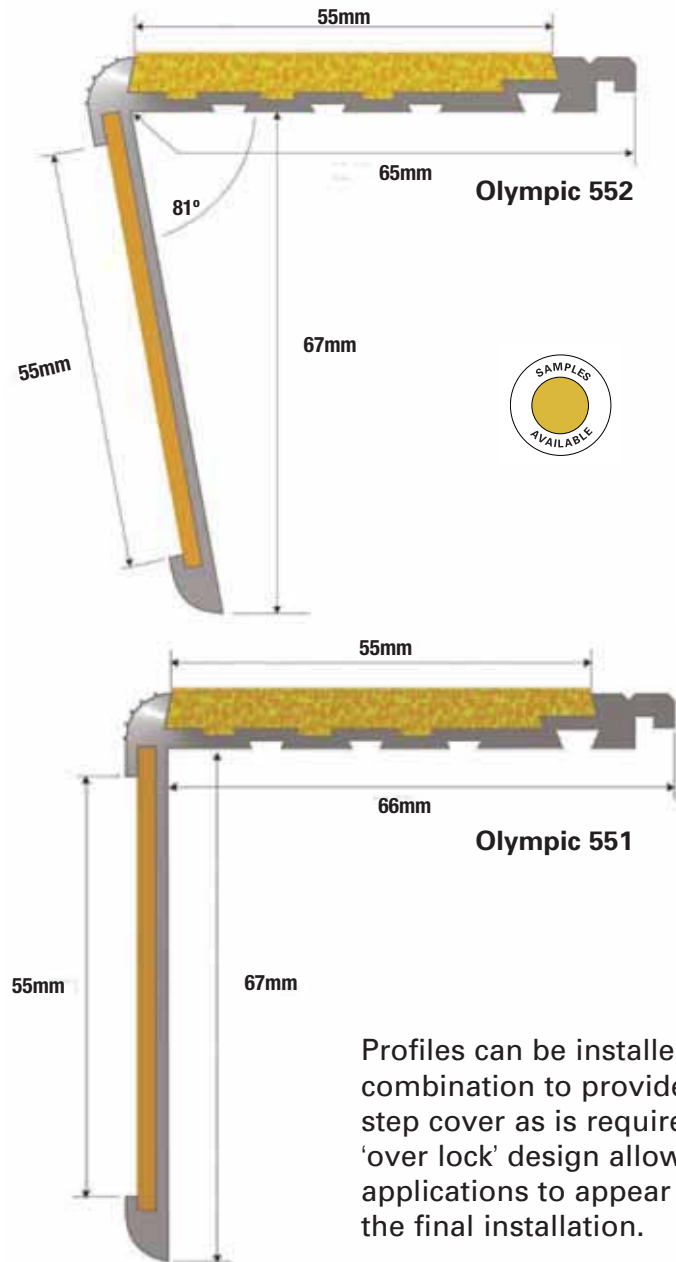

## MODULAR RANGE

Durable anti slip for industrial and commercial steps. 7mm gauge.

Olympic stair nosings contain carbogrip infilling consisting of coloured aggregates with aluminium oxide in cured epoxy resin producing an anti-slip medium which is extremely durable.

Ideal for external applications and for internal wet environments.

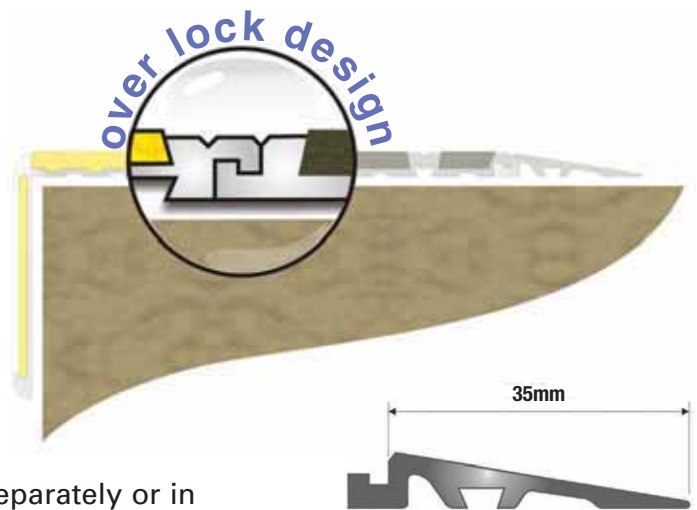
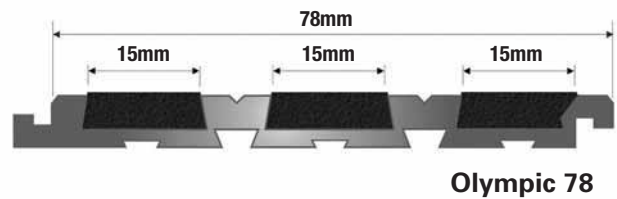
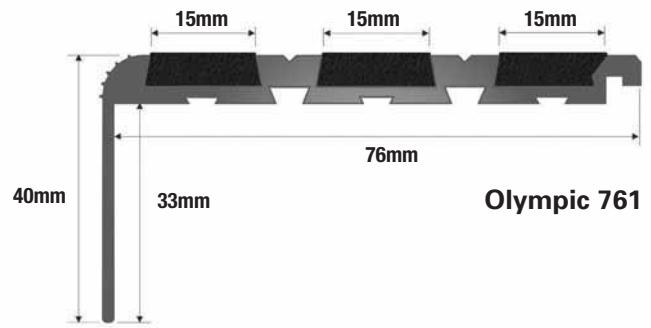

Profiles can be installed separately or in combination to provide as much or as little step cover as is required. The featured 'over lock' design allows multi-section applications to appear as a single piece in the final installation.



The design of the overlook - underlock feature in the modular profiles provides part or full going cover to steps and landings.

Once installed, the combination appears as if a single piece.



## Example modular combinations:

**Olympic 551/35**

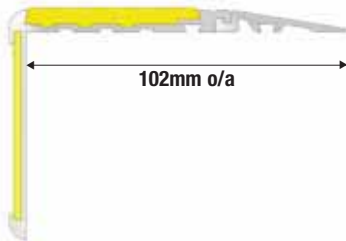

**Olympic 551/78/35**

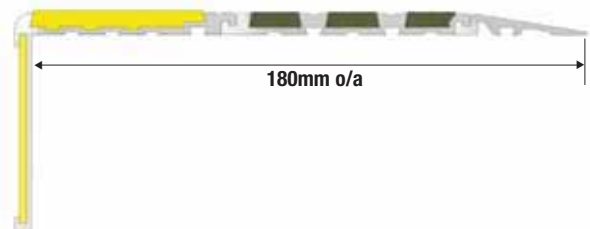

**Olympic 551/78/78/35**

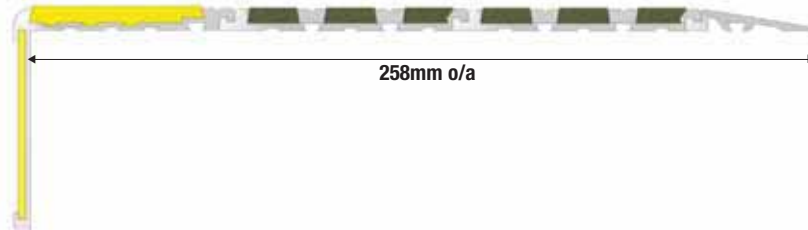

**Olympic 551/78/78/78/35**



**Olympic 761/35**

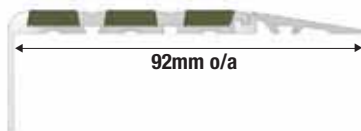

**Olympic 761/78/35**



**Olympic 761/78/78/35**

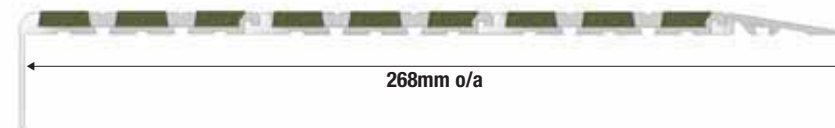

**Olympic 761/78/78/78/35**





# OLYMPIC HEAVY DUTY STAIR NOSINGS



Stair nosings with feathered edges for surface mount to industrial and commercial steps.

- 5mm gauge.

Carbigrip infill for external applications and internal wet environments.

Slip resistance info is available upon request.

Supplied cut to size • maximum 2.5m length.  
Pre-drilled and countersunk for No. 8 screws.

Tread profiles are 5mm thick (aluminium).

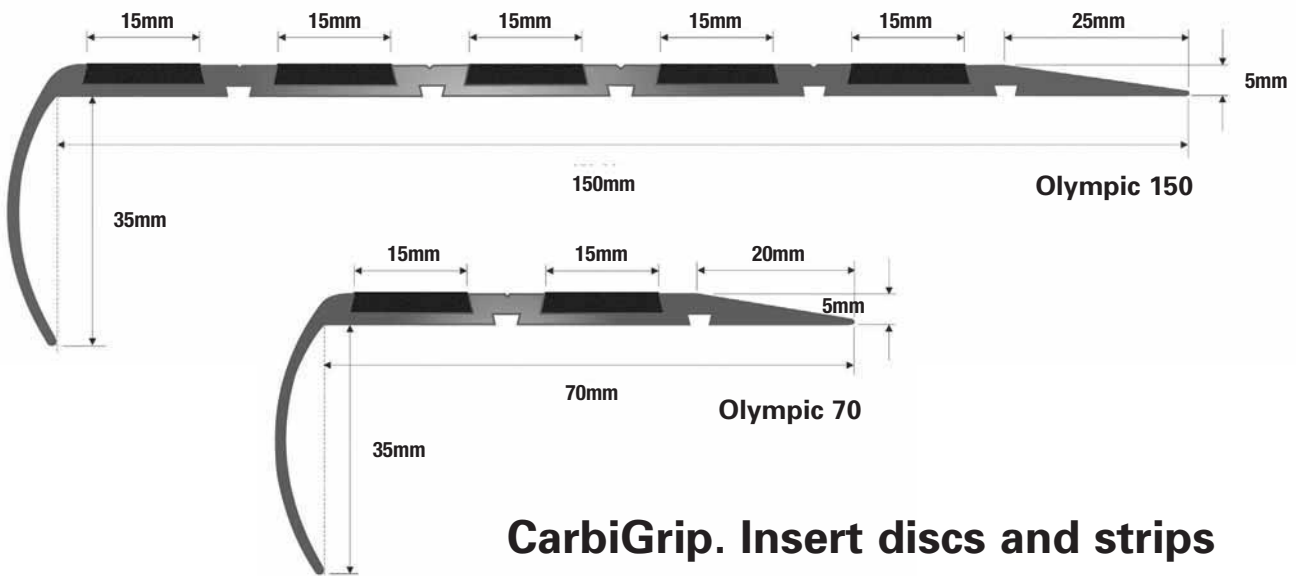

## CarbiGrip. Insert discs and strips

Olympic Disc 50mm

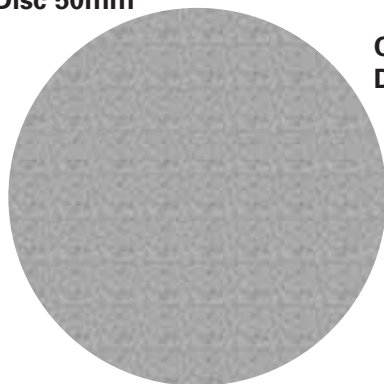

Olympic Disc 25mm

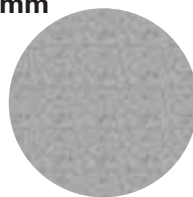

OLYMPIC discs are available in two diameters 25 and 50mm in 8mm gauge, 10 per pack.

Strips are available in 10, 25, 35 and 55mm widths. Supplied cut to size - maximum 2000mm length.

Olympic Strip 10

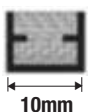

Olympic Strip 25

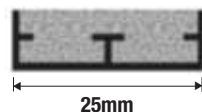

Olympic Strip 35

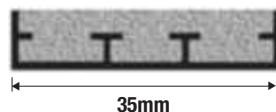

Olympic Strip 55

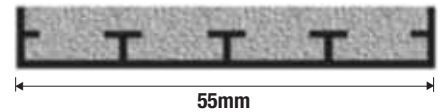



## Profile Modification

If the standard profiles (or combinations thereof) won't satisfy a particular application, certain modifications can be made which might make them more suitable.

So, if for example Olympic 761 is too deep at 78mm, then this can be reduced by ripping through the aluminium between the ribs of the Carbigrip infilling. The position of the rip can be anywhere but at least 5mm of aluminium must be left at the back of the modification to retain the Carbigrip.

Profiles modified in this way may still be used in combination, albeit they will be butted together rather than over/under-locked in the final installation.

Equally, if the nosing drop is too deep, this can be reduced and even removed to render a flat plate.

### Typical Examples:

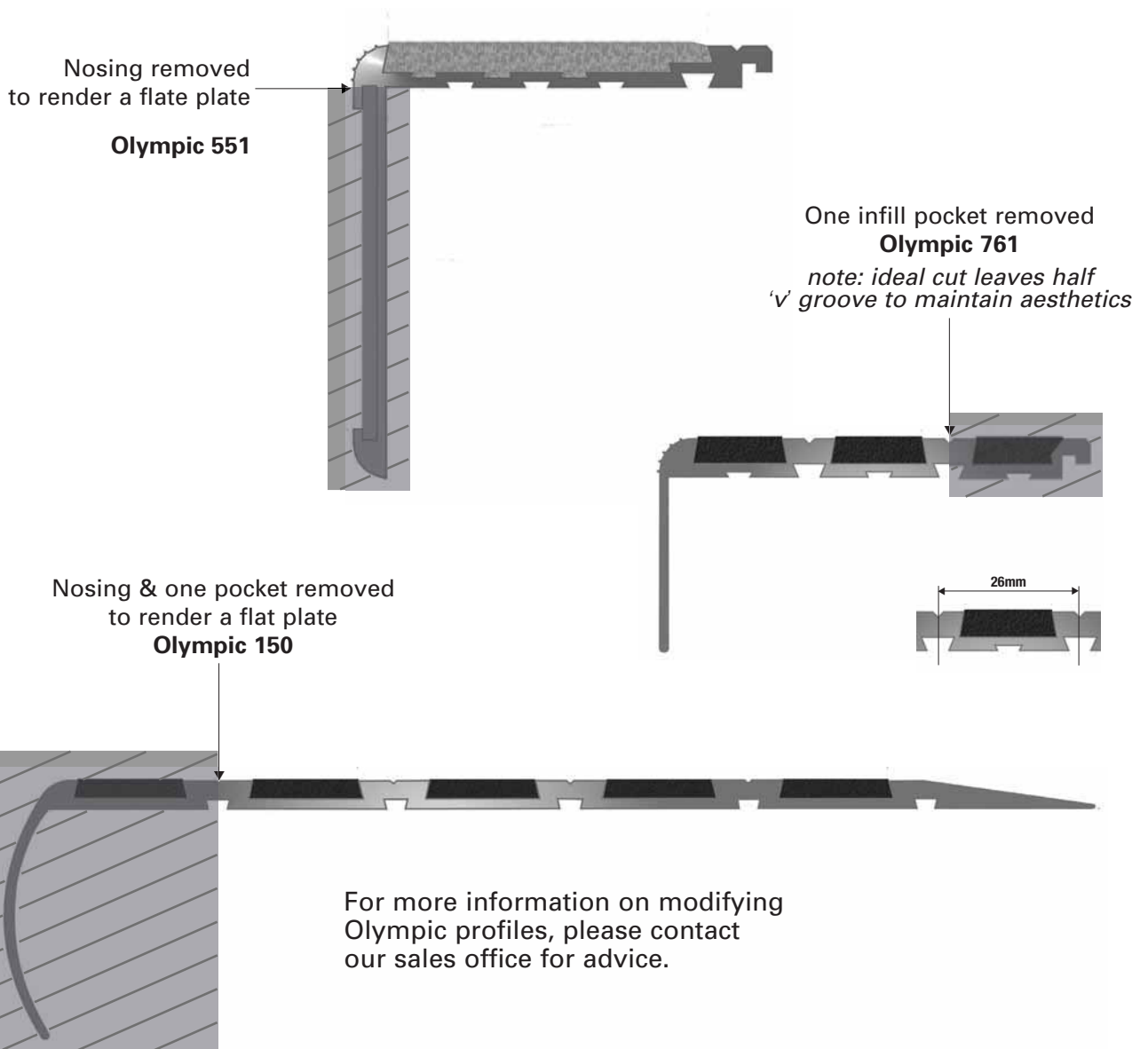

For more information on modifying Olympic profiles, please contact our sales office for advice.

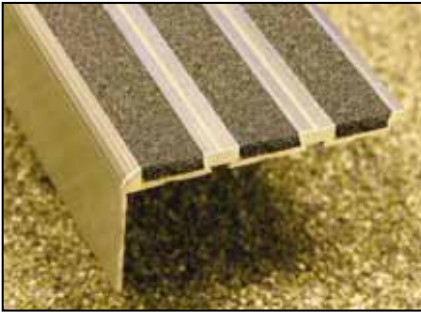

## Profile Modification - cont.

Illustrated are finished examples of modified profiles, with descriptions given of finished products.



Profile Olympic 551 with nosing face removed to produce a flat strip for positioning at the step edge.



Profile Olympic 761 with nosing face removed to produce a flat strip for positioning at the step edge.



Profile Olympic 78 with 'underlock' feature removed to produce a flat strip for positioning back from the step edge.



Profile Olympic 78 with 'underlock' feature and one tread pocket removed to produce a flat strip for positioning back from the step edge.



Profile Olympic 78 with 'underlock' feature and two tread pockets removed to produce a flat strip for positioning back from the step edge.



Profile Olympic 70 with nosing face removed to produce a sit-on flat strip for positioning at the step edge.



Profile Olympic 150 with nosing face removed to produce a sit-on flat strip for positioning at the step edge.



Profile Olympic 150 with nosing face and one tread pocket removed, placed face to face with an identical piece to produce a threshold plate.



## Technical Data



**Stair Nosing Profiles.** mill finish 6063 aluminium alloy, hardened to T6.

**CarbiGrip** infill - coloured aggregates with aluminium oxide in cured resin.

**CarbiGrip** colours - yellow, white and black.  
Slip resistance info is available upon request.

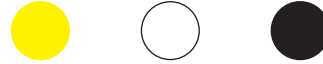

## Stair Nosing Maintenance

To ensure effective anti-slip is maintained and that the edge of the step(s) remains adequately defined, the installed nosings and treads must be cleaned on a regular bases. Cleaning should be carried out by gently scrubbing with a solution of proprietary detergent and warm water.

The aluminium profile(s) can be buffed using a fine grade steel wool or similar.

## Fixing

### Stair Nosings - standard drilling

All aluminium profiles, except Olympic 35, are supplied pre-drilled and countersunk for No.8 screws unless otherwise requested. Holes are through the aluminium, centred in the v-groove(s), as shown below:

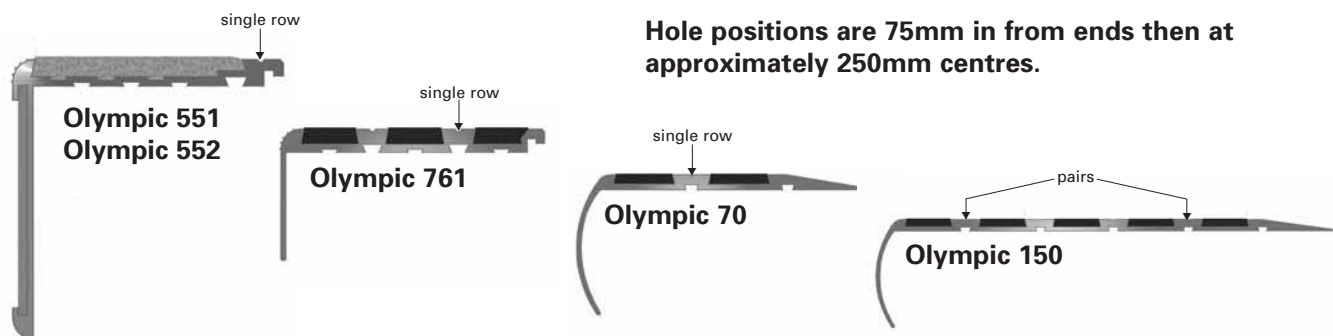

## Recommended Fixings

As with all installations, the substrate must be sound and reasonably level. Any remedial work must be done before installing the profile(s).

The heavy duty nature of Carbigrip filled profiles requires that they are always screw fixed. It is also advisable to bed all profiles on to a suitable adhesive to reduce/remove the potential for 'rattle' in the finished installation.

The recommended screw size is a No.8 (M5) woodscrew with a countersunk head to suit the standard pre-drilled holes. Always use stainless steel screws (or bolts/nuts if fixing to steel plate).

The chosen bedding adhesive must be suitable for external use (recommendations are available) and used in accordance with the manufacturers recommendations.

Where fixing has to be by adhesive only, use a product with high strength mechanical properties which is specifically designed for structural bonding (recommendations are available). Cartridge adhesives typically used for fixing decorative nosings; e.g. Gripfill, F32 etc., are not recommended for this purpose.

## Olympic Discs and Insert Strips

### Recommended Fixing

Discs and strips are bonded into a preformed hole/rebate using a suitable adhesive. Prepare the adhesive as instructed by the manufacturer, then coat the back of the disk/strip and position into hole/rebate. Apply weights and leave undisturbed until adhesive has fully cured.

*For information on adhesives please contact our sales office.*



Indicator corduroys and studs with integral slip resistant features for interior and exterior applications.



Produced from durable polyurethane (ref PT) Olympic corduroys and studs provide a raised tactile of 6mm above ground level when installed.

A choice of colours to ensure optimum contrast with the substrate material.

Black • Grey • Beige • Yellow  
Other colours subject to minimum quantity.

### OC PT 390

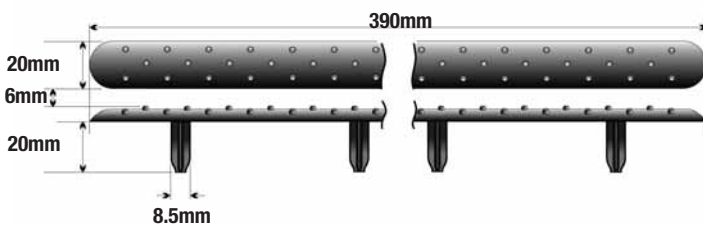

### Olympic Corduroy

390mm long  
x 20mm wide.  
6mm high.  
Radiused ends.

**pack quantity 8**  
(sufficient for standard  
400 x 400mm panel)

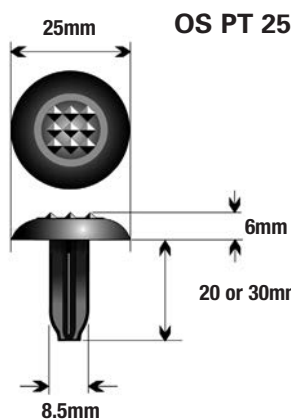
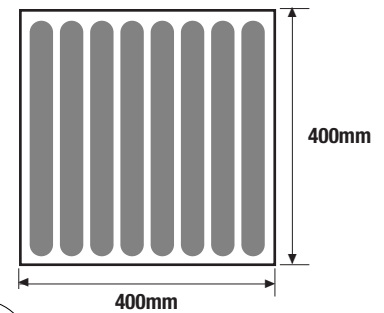

### OS PT 25

**Olympic Stud**  
Cross hatch surface.  
25mm diameter.

**pack quantity 36**  
(sufficient for standard  
400 x 400mm panel)

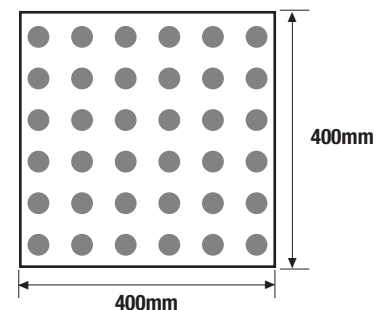

### OS SS 25

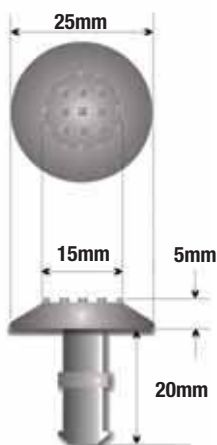

### OS SS 25/KG



Olympic stainless steel indicator studs. Grade 316 OS SS 25 cross hatch surface 25mm diameter. OS SS 25/KG K-GRIP is a durable proven slip resistant medium for interior and exterior applications. K-GRIP colours Black • Grey • Yellow • other colours subject to minimum quantity.

### Product Installation

Installation of Olympic corduroys and studs is by drilling of locating holes (from templates) and by securing the anchor peg with adhesive. Further information available from our sales office.



Olympic indicator studs  
OS PT 25



Olympic Discs



Indicator Corduroys



Stainless Steel curves for fixing around columns

On occasions a project will arise that requires a special product and in this situation C.A.T. is here to help you.

With our extensive knowledge of solving problems C.A.T. seek to provide a solution to customer enquiries.



### Extruded Profiles

Available in aluminium • brass • pvc • upvc

Suitable for larger quantity requirements.

Typical minimum order run 1000 metres plus.

Subject to design.



### Profile Forming

Available in aluminium • brass • stainless steel

Suitable for small to medium quantity requirements.

Typical minimum order run 50 metres plus.

Subject to design.



### Laser Cutting from sheet

Available in aluminium • brass • stainless steel

Popular enquiry - circular flat plates for foyer revolving doors.

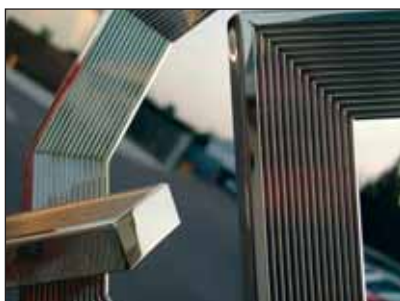

### Fabrication

All aspects of metal fabrication including; welding • curving • finishing • polishing



**CAT Sampling Service**

To assist with product selection we provide a sample service for all CAT products and for those customers wishing to display products a variety of boards are available.

For information please contact our Sales Office on 01582 561500



**Brass Chrome and special finish profiles**

**Aluminium Profiles**

**KLIKS Clip in Profiles**

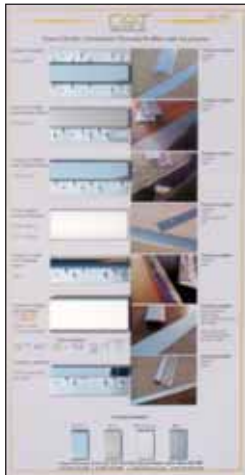

**Spectrum Profiles**

**Stair Rod Board Profiles**

**Stair Rod Staircase**

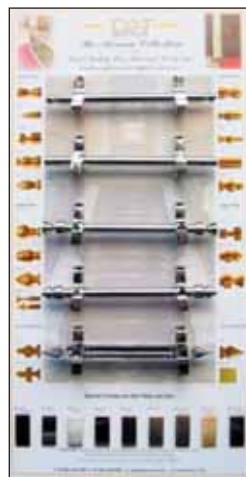

**Sample Fobs**



A range of sample fobs are available including Stair Nosings, Stair Rod Finials and various trims



## Purchase Order Form - General

**1.5% Discount on all Orders Placed on this Template Form.**

Orders placed subject to C.A.T. normal Terms and Conditions of Sale

INVOICE ADDRESS:	DELIVERY ADDRESS:
TEL	TEL
FAX	FAX
EMAIL	EMAIL

COMPANY	CONTACT
TEL	
FAX	
EMAIL	ORDER NO.
ACCOUNT NO.	
DATE OF ORDER	
DELIVERY DATE	

### PRODUCTS

--

### SPECIAL INSTRUCTIONS

--



## Purchase Order Form for Stair Nosings

**1.5% Discount on all Orders Placed on this Template Form.**

Orders placed subject to C.A.T. normal Terms and Conditions of Sale

COMPANY		INVOICE ADDRESS:	
CONTACT			
TEL			
FAX			
EMAIL		DELIVERY ADDRESS:	
ORDER NO.			
ACCOUNT NO.			
DATE OF ORDER			
DELIVERY DATE			

### MEASURING

Steps should be measured and numbered from the top of the staircase to the bottom, indicating flights and landings for the cutting and installation plan. For curved steps please refer to stair nosing fabrication section for advice on templating.

Stair nosings can be supplied in various lengths.

- stock lengths
- cut to size
- oversize (by 30mm) if specified for cutting on site

### ORDER

Nosing reference		Insert colour	
Drilled		Undrilled	
Curves / Yes		No	

### SIZES

### SPECIAL INSTRUCTIONS



**The Akeman Collection**  
**Purchase Order Form for Stair Rods, Eyes and Stair Clips**

*1.5% Discount on all Orders Placed on this Template Form.*  
 Orders placed subject to C.A.T. normal Terms and Conditions of Sale

COMPANY		INVOICE ADDRESS:
CONTACT		
TEL		
FAX		
EMAIL		DELIVERY ADDRESS:
ORDER NO.		
ACCOUNT NO.		
DATE OF ORDER		
DELIVERY DATE		

STAIR RODS		FIXING EYES – sold in pairs	
ROD TYPE		EYE TYPE	
DIAMETER			
FINIAL TYPE		QUANTITY	
FINISH			

SIZES: TIP TO TIP MEASUREMENT	STAIR CLIPS	
	FINISH	
	NUMBER OF CLIPS IN PAIRS	

**SPECIAL INSTRUCTIONS**

**TIPS FOR MEASURING STAIR RODS**

For rods with carpet runners, measure the full width of the runner and add a minimum of 100mm for 10mm, 12mm and 16mm turned rods and 150mm for rods with large finials having given consideration to available staircase width.

For rods with full width carpets using top fix eyes, measure stairs full width and deduct a suitable amount to create best effect. Always number stairs from top down to bottom.

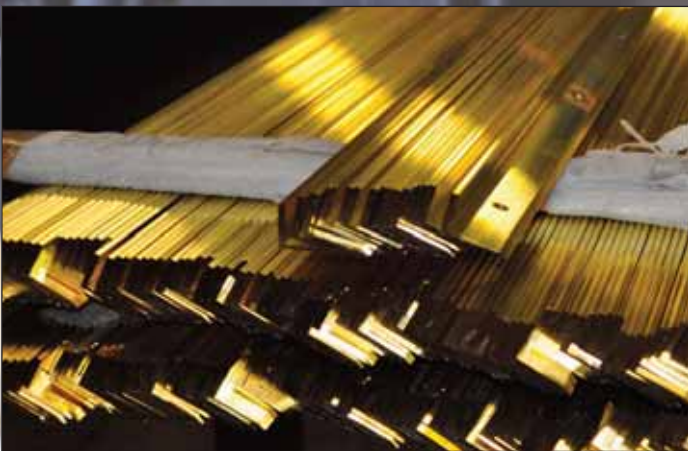
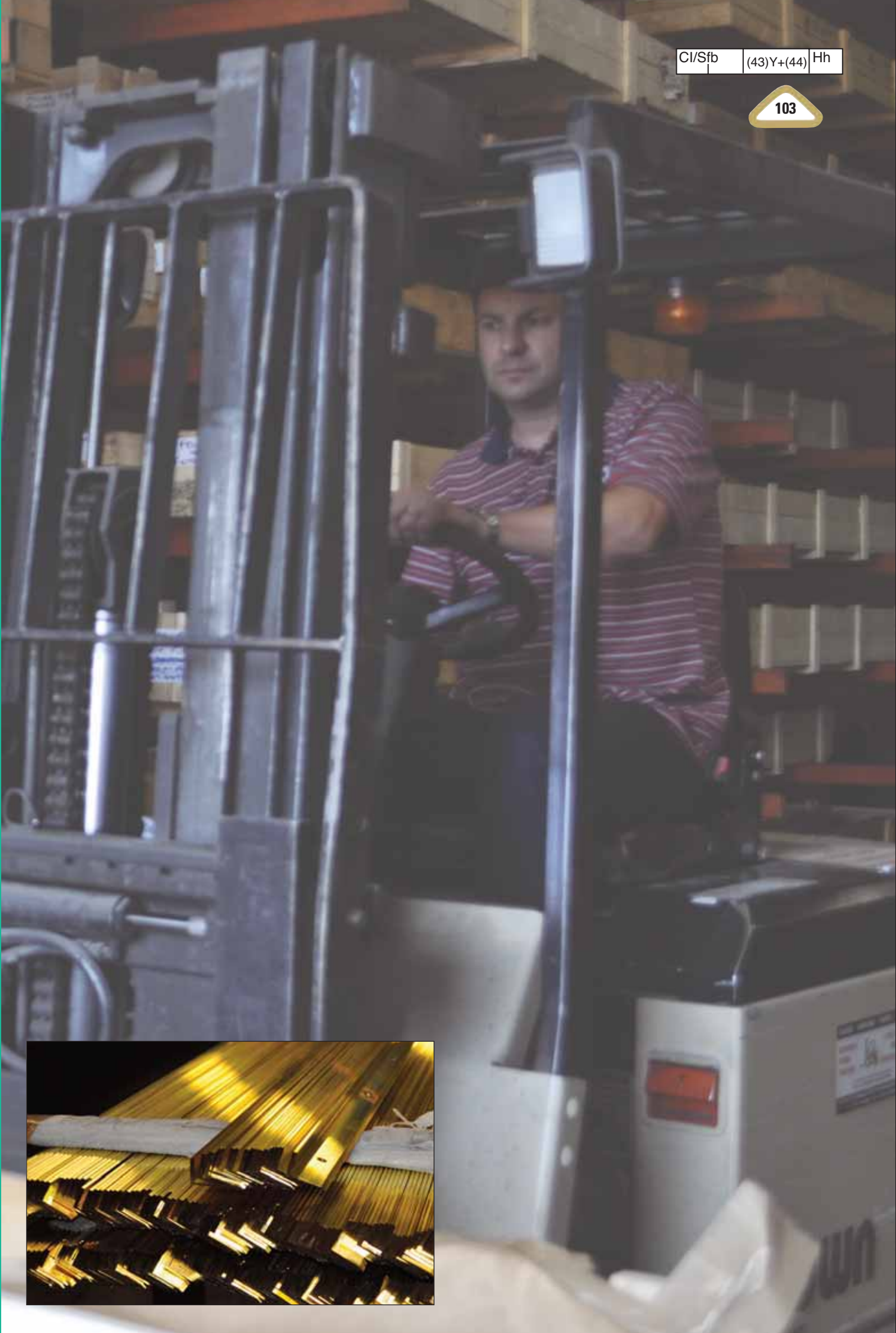



A13	24	BEP2	17,19	FELINE EDGE	14
A16	24	BLE	22	FELINE S1	12
A19	24	BME	48	FELINE S13	12
A22.5	24	BN1	71	FELINE S2	11
A25	24	BN11	71	FELINE ST	11
A3	24	BN12	68	FELINE T	11
A4.5	24	BN14	69	FPA 10x3	19
A6.5	24	BN15	69	FPA 10x6	19
A9	24	BN16	68	FPA 12x3	19
AC100	16	BN17	68	FPB 10x3	19
AC110	16	BN18	68	FPB 10x6	19
AC 135	16	BN19	68	FPB 12x3	19
AC38	15,52	BN2	71	FPSS 10x4	19
AC50/50	47	BN20	69	FPSS 12x5	19
AC55	15,52	BN20/15	69	FTRS12	22
AC80	16	BN21	69	IN STEP DISCS	60
AC82	16	BN3	67	KB1	30,31,33,36,38,41
AE32	72	BN4	71	KB2	30-33,36,38,41
AE32/S	72	BN42	67	KB3	30-33,36,38,41
AEP1	19	BN52	67	KK101	33
AEP2	19	BN55	67	KK102	30
AN1	72	BN55	67	KK103	31
AN14	69	BN6	67	KK104	32
AN15	69	BN7	71	KK111	33
AN2	72	BN74	71	KK112	30
AN20	69	BN79	68	KK113	31
AN20/15	69	BN8	67	KK114	32
AN21	69	BN90	71	KK121	33
AN3	73	BNF	13,50	KK122	30
AN4	73	BNR	13,50	KK123	31
AN5	73	BR12	22	KK124	32
AN55	72	BR14	22	KK131	33
AN6	73	BR20	22	KK132	30
AN60	72	BR8	22	KK133	31
AN7	73	BR9	22	KK134	32
ANF	13,52	BSE	14	KK141	33,52
AR12	21	BSE2	14	KK142	33,52
AR63	21	BTG2	11	KK143	33,52
AR65	21	BTG2/SL	12	KK151	33,52
AR65/2	21	C13	27	KK152	33,52
AR8	21	C16	27	KK153	33,52
B13	25	C6.5	27	KK2	30,50
B155	17	C9	27	KK202	30
B16	25	CAP IT	14,47,52	KK203	31
B25	25	CAT1	13	KK212	30
B25HD	25	FELINE 1	12,50	KK213	31
B4.5	25	FELINE 2	11,50	KK222	30
B6.5	25	FELINES	12,50	KK223	31
B9	25	FELINE 4	11,50	KK232	30
B19	25	FELINE 9	14	KK233	31
BA	48	FELINE A/10	12,52	KK242	30
BC30	17	FELINE A/13	12,52	KK243	31
BC38	17,50	FELINE A/9/2	11,52	KK252	30
BC55	17,50	FELINE A/T	52	KK253	31
BEP1	17,19				



## ALPHABETICAL & NUMERICAL PRODUCT INDEX

KK3	31,50	S6.5	26	TOB133	46
KSP5 ZIP	36,37,41,42	S9	26	TOB134	46
KSP6 ZIP	38,39,41,42	SA	48	TOB135	45
KSP7 ZIP	40	SC30	18	TOB3	46
MATWELL FRAMES	48	SC38	18	TTA13	24
OC PT 390	94	SC50/50	47	TTA16	24
OLYMPIC 150	90,91,93	SC55	18	TTA19	24
OLYMPIC 35	88,89	SC60	18	TTA22.5	24
OLYMPIC 551	88,89,91,93	SLE	22	TTA25	24
OLYMPIC 552	88,89,93	SME	48	TTA3	24
OLYMPIC 70	90,93	SN60	70	TTA4.5	24
OLYMPIC 761	88,89,91,93	SNE	67	TTA6.5	24
OLYMPIC 78	88,89	SR12	22	TTA9	24
OLYMPIC DISC 50	90	SR14	22	TTB13	25
OLYMPIC DISC 25	90	SR20	22	TTB16	25
OLYMPIC STRIP 10	90	SR8	22	TTB19	25
OLYMPIC STRIP 25	90	SR9	22	TTB25	25
OLYMPIC STRIP 35	90	SS10	14	TTB4.5	25
OLYMPIC STRIP 55	90	SSE	14,47	TTB6.5	25
OS PT 25	94	SSEP1	18,19	TTB9	25
OS SS 25	94	SSEP2	18,19	TTC13	27
OS SS 25/KG	94	SSNF	13	TTC16	27
P12 FLEXI	44	STAIR RODS AND EYES 77-85		TTC6.5	27
P8 FLEXI	44	T36	44	TTC9	27
RAD13	58	T78i	20	TTCAT1	13
RAD16	58	T80i	20	TTS12	26
RAD19	58	TIMBERLINE 1/12	28	TTS16	26
RAD9	58	TIMBERLINE 1/15	28	TTS19	26
RAP 13	58	TIMBERLINE 1/22	28	TTS22	26
RAS13	58	TIMBERLINE 2/12	28	TTS25	26
RAS16	58	TIMBERLINE 2/13	28	TTS6.5	26
RAS19	58	TIMBERLINE 2/15	28	TTS9	26
RAS9	58	TIMBERLINE 2/22	28	VERTEX 1A	57
RBD13	58	TIMBERLINE 3/15	28	VERTEX 1S	57
RBD16	58	TIMBERLINE 4/128	28	VERTEX 22A	57
RBD19	58	TIMBERLINE 4/1510	28	VERTEX 22S	57
RBD9	58	TIMBERLINE 4/2210	28	VERTEX 2A	57
RBP13	58	TOB101	45	VERTEX 2S	57
RBS13	58	TOB102	45	VERTEX 31A	57
RBS16	58	TOB103	46	VERTEX 31 S	57
RBS19	58	TOB104	46	VERTEX 3A	57
RBS9	58	TOB105	45	VERTEX 3S	57
RSD13	58	TOB111	45	VERTEX 41A	57
RSD9	58	TOB112	45	VERTEX 41 S	57
RSS13	58	TOB113	46		
RSS9	58	TOB114	46		
RT39	44	TOB115	45		
SCAP	47	TOB121	45		
S12	26	TOB122	45		
S155	18	TOB123	46		
S16	26	TOB124	46		
S19	26	TOB125	45		
S22	26	TOB131	45		
S25	26	TOB132	45		







© OCTOBER 2010



Treadsafe Distributors Ltd.  
Unit 11, Finglas Business Park,  
Tolka Valley Road, Dublin 11, Ireland  
Tel: +353 1 834 0683  
Fax: +353 1 834 0689  
Email: [sales@treadsafe.ie](mailto:sales@treadsafe.ie)

[www.treadsafe.ie](http://www.treadsafe.ie)

**ts**<sub>D</sub>  
**treadsafe**  
distributors